

WYNDHAM COLLECTION

Edge Profile - Eased

Note - All Measurements are $\pm 1/4"$.

Due to the high probability of breakage, **the backsplash comes in two pieces**, cut from the same piece.

Replacement for Wyndham Collection products (except Andover).

Products from other brands may not be compatible.

Cultured marble is created in batches and slight variations from batch to batch are possible. We cannot guarantee an exact match to your existing counter.

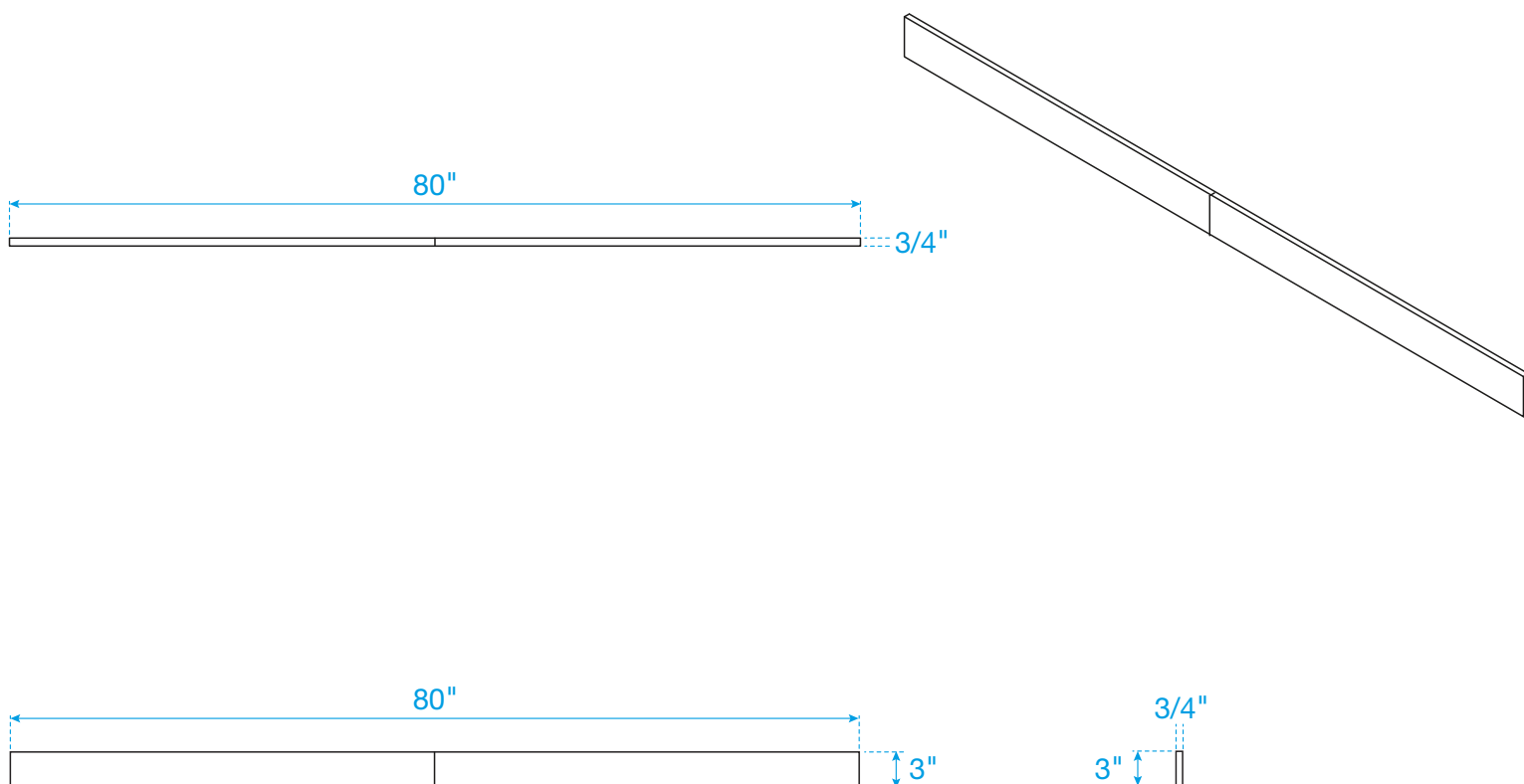

WC-VCA-80-BS