

WYNDHAM COLLECTION

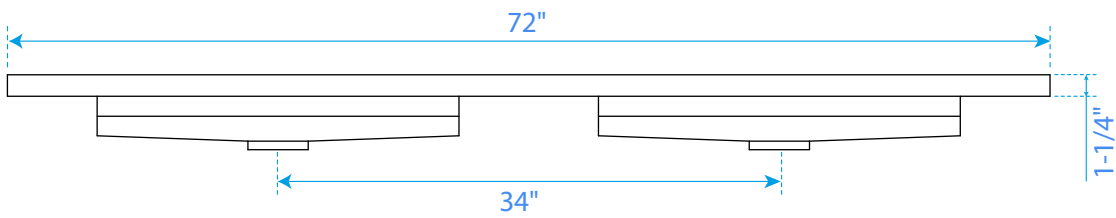
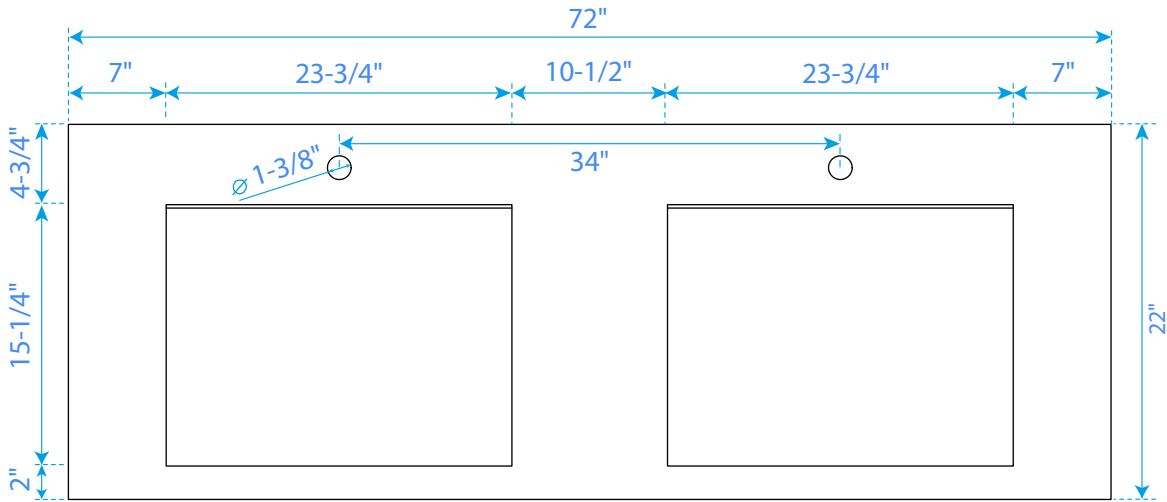
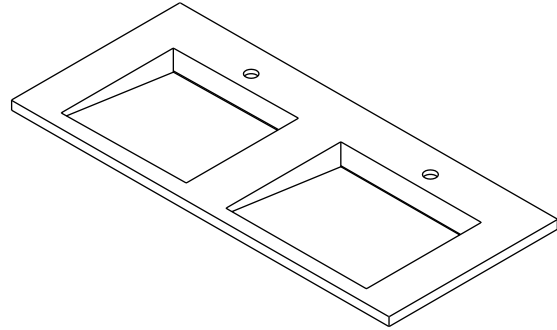
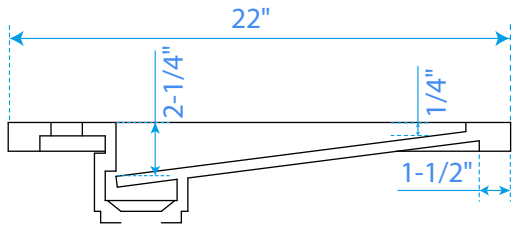

*Note: All measurements are $\pm 1/4"$.

WC-KCI-72-DBL-TOP