

WYNDHAM COLLECTION

Exterior Size - 67"L x 27-1/2"W x 23"H
Depth at Drain - 18"
Drain to Overflow - 15"
Maximum Fill - 60 Gallons
Note - All Measurements are $\pm 1/2$ "

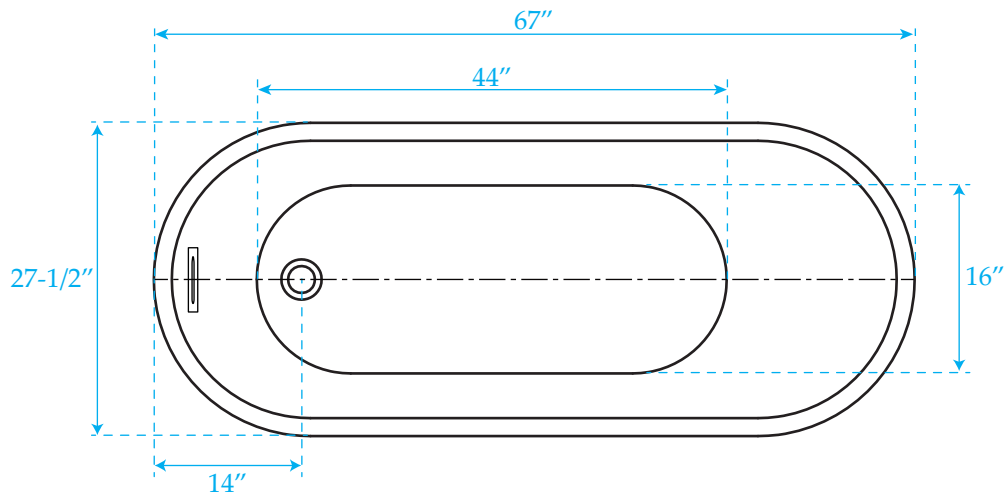
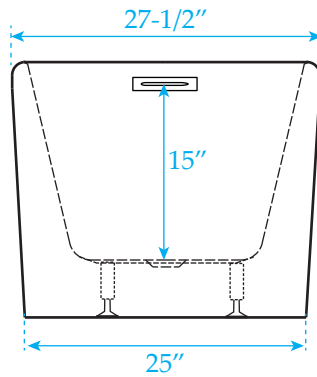
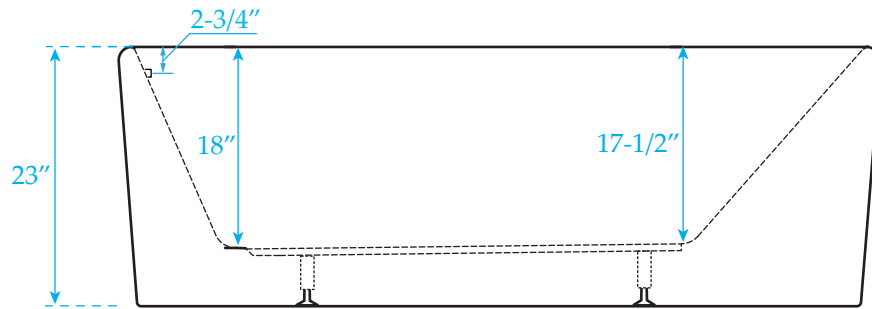

WC-BTE1511-67