

WYNDHAM COLLECTION

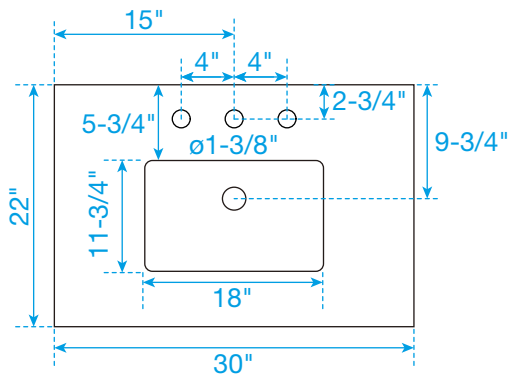

TOP VIEW OF VANITY CABINET

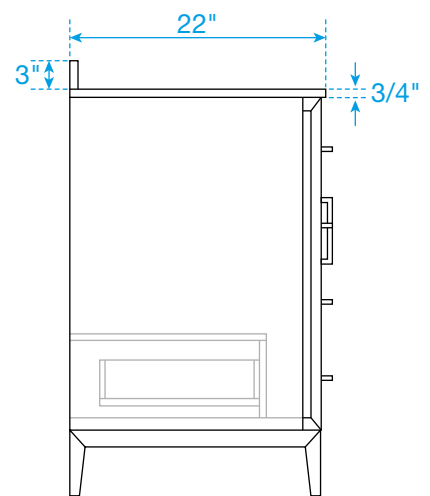
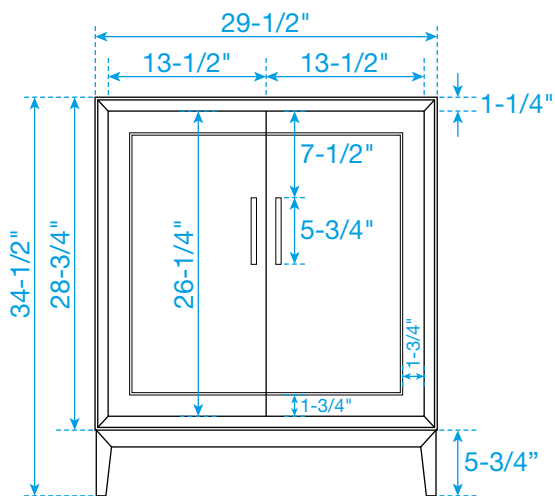
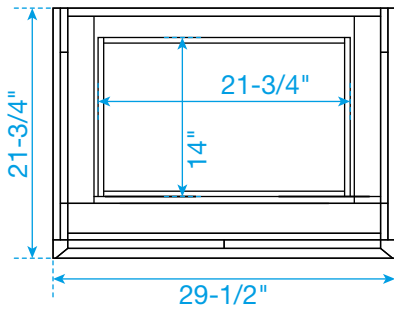
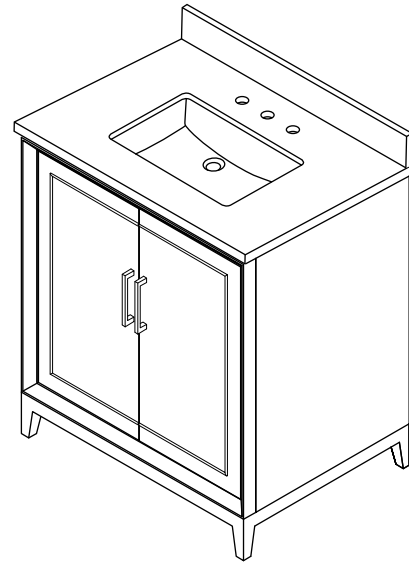

*Note: All measurements are $\pm 1/4$ ".

WC-5151-30-SGL Quartz