

# WYNDHAM COLLECTION

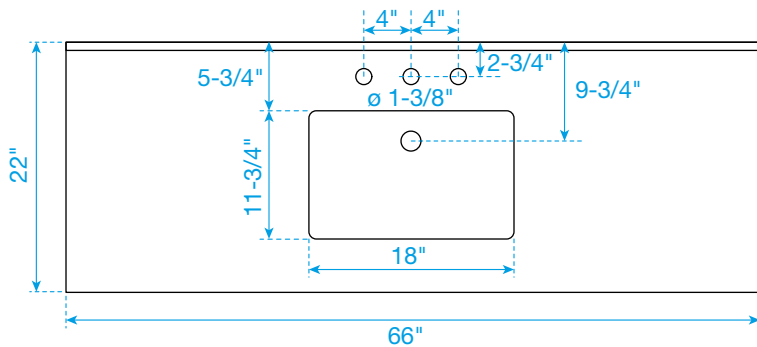

TOP VIEW OF VANITY CABINET

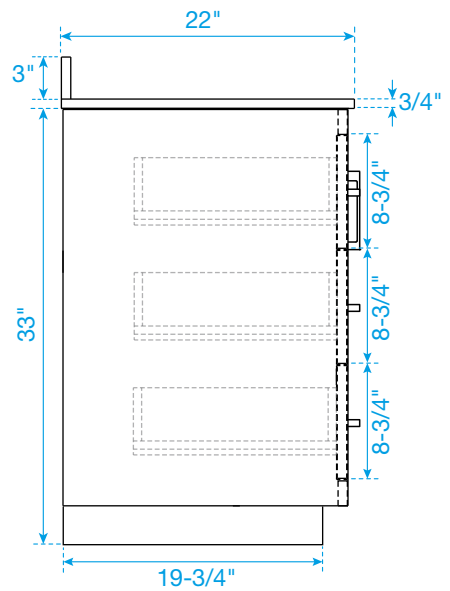
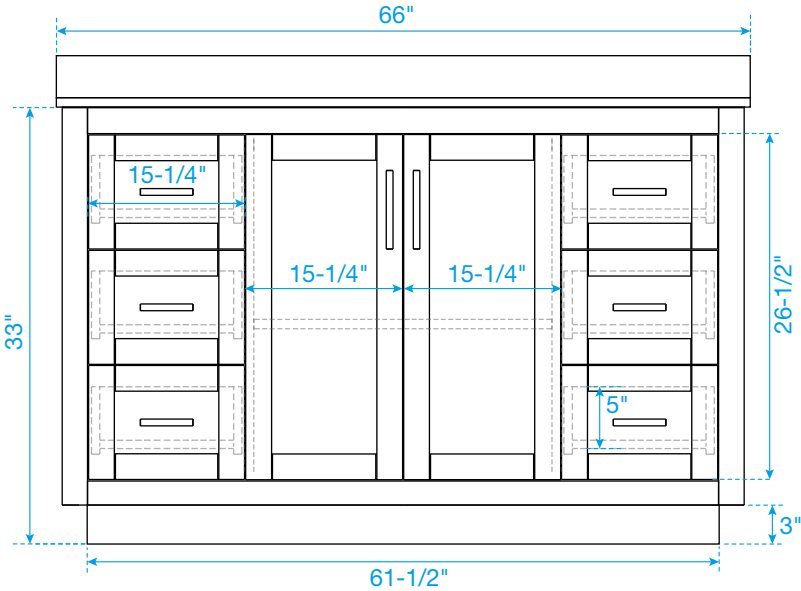
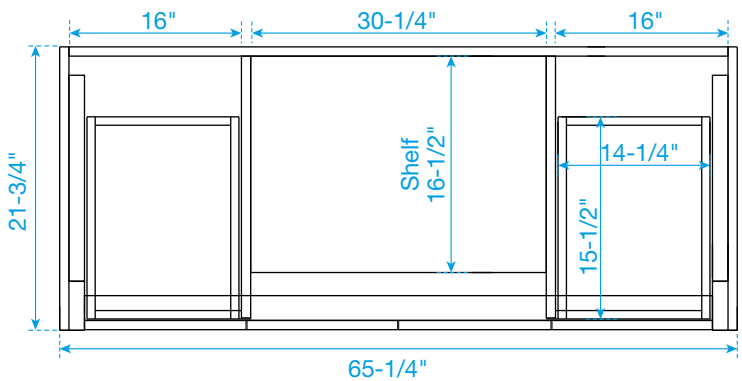
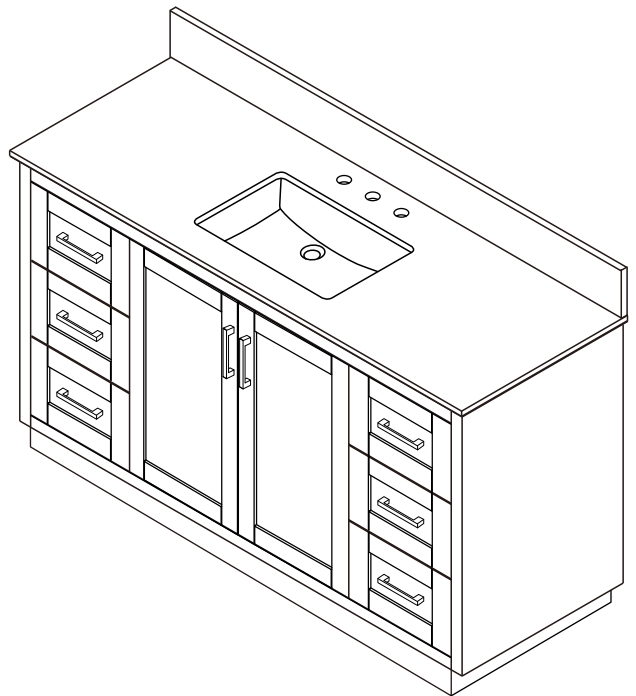

\*Note: All measurements are  $\pm 1/4"$ .

## WC-2929-66-SGL Quartz