

WYNDHAM COLLECTION

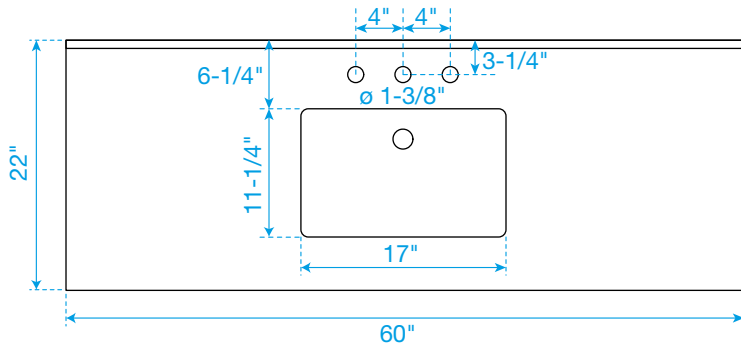

TOP VIEW OF VANITY CABINET

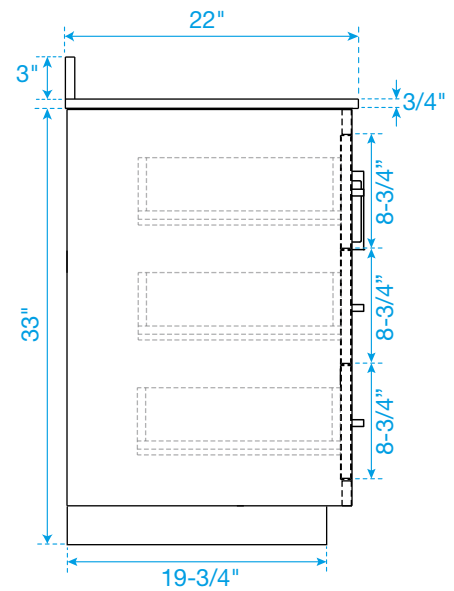
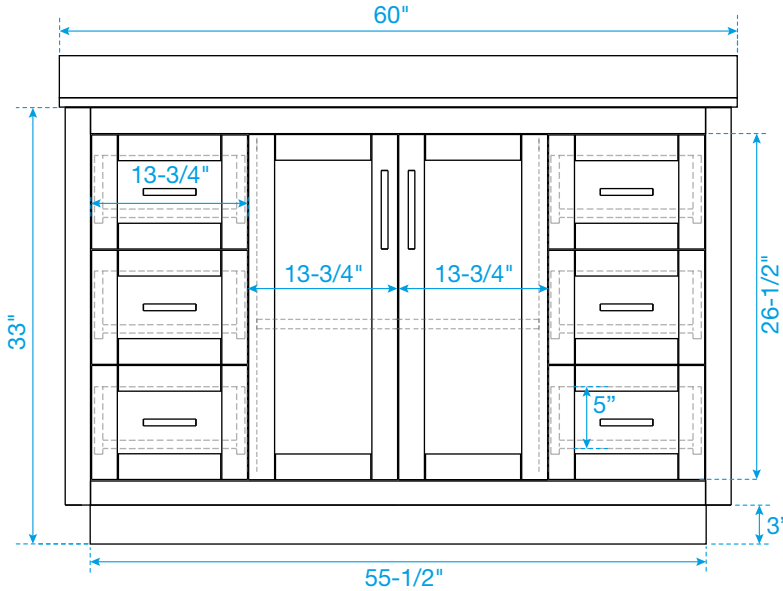
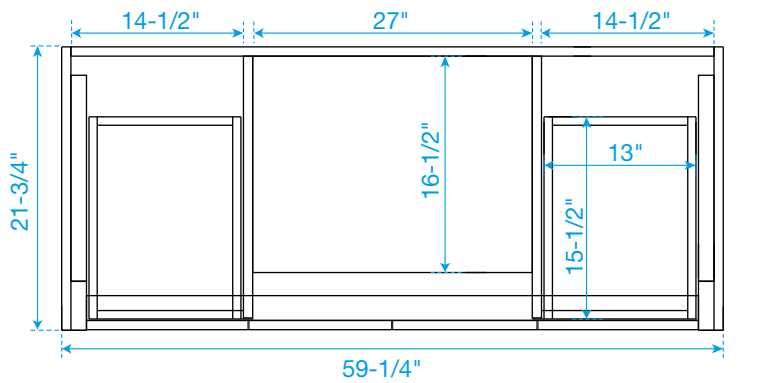
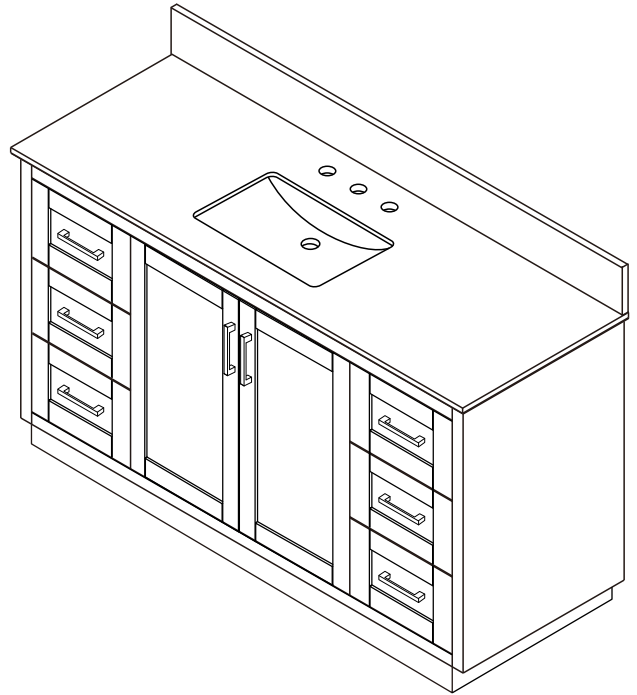

*Note: Due to high probability of breakage, the backsplash comes in two pieces, cut from the same piece. All measurements are $\pm 1/4"$.

WC-2929-60-SGL-VCA3