

WYNDHAM COLLECTION

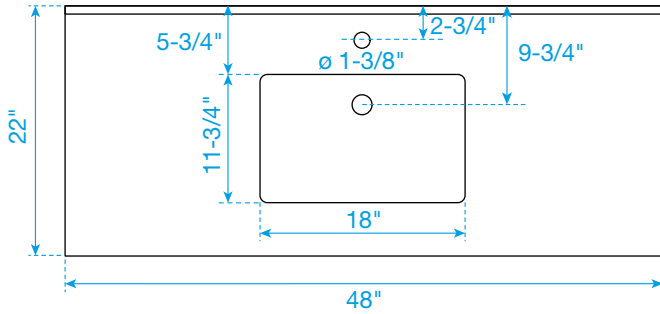

TOP VIEW OF VANITY CABINET

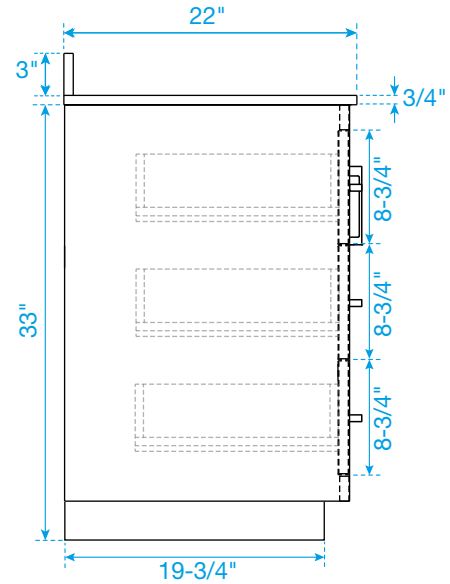
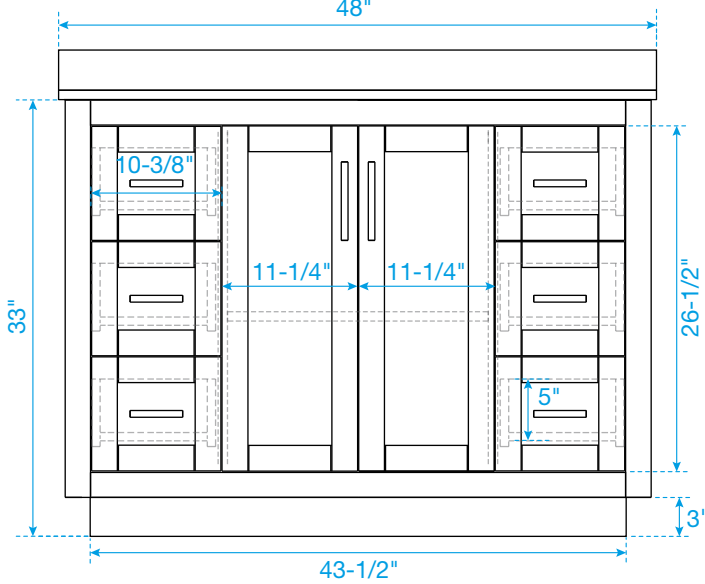
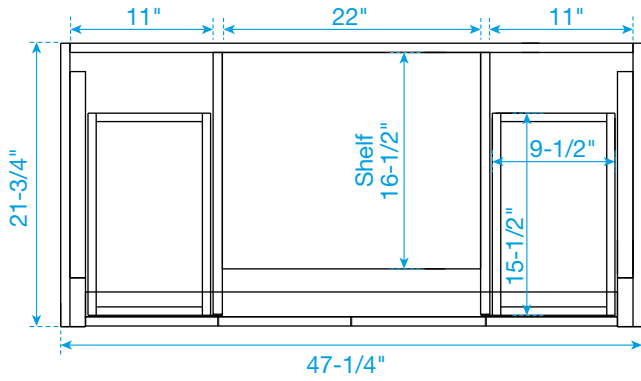
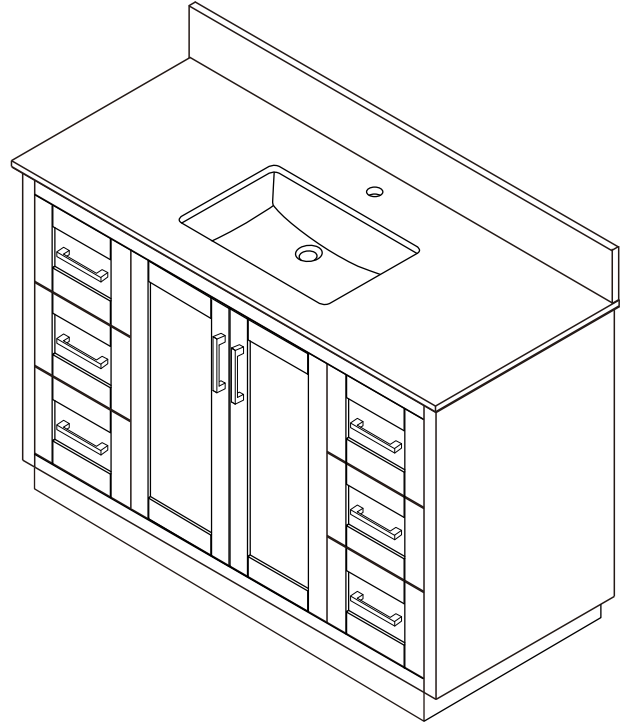

*Note: All measurements are $\pm 1/4"$.

WC-2929-48-SGL Quartz