

# WYNDHAM COLLECTION

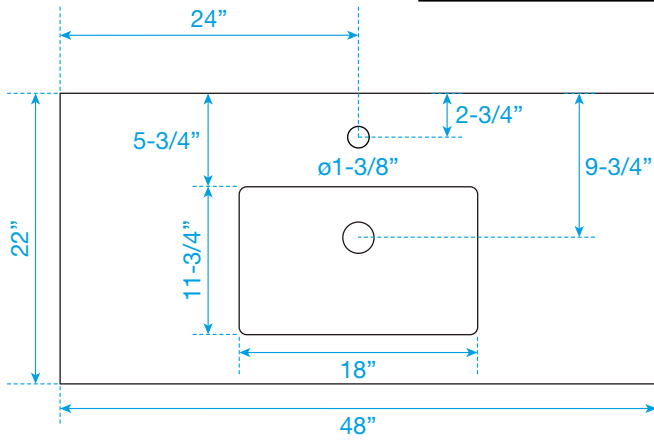

TOP VIEW OF VANITY CABINET

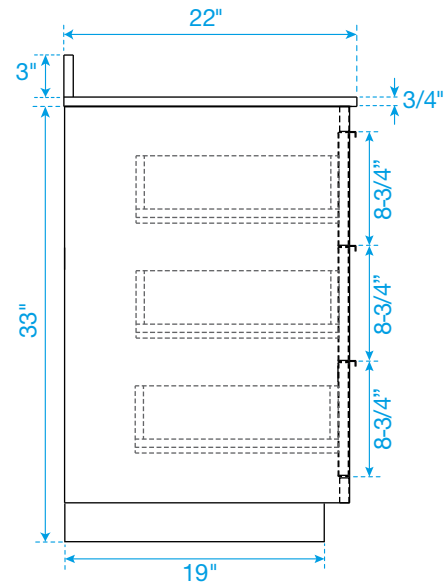
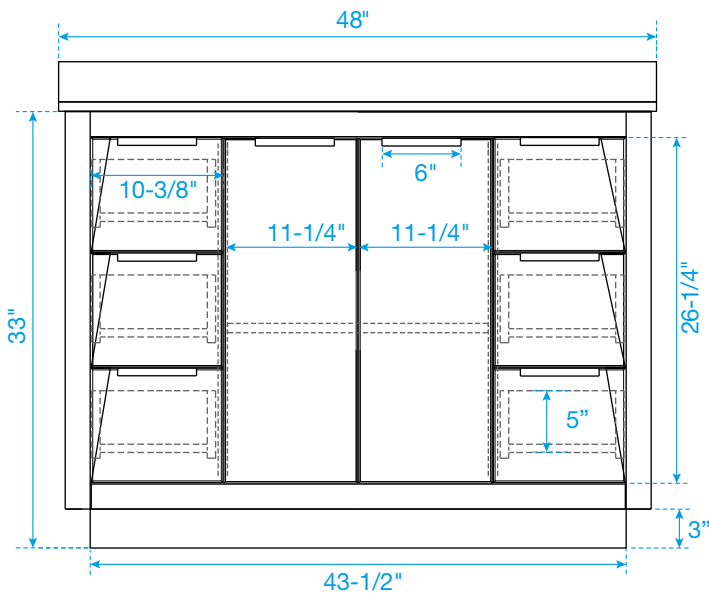
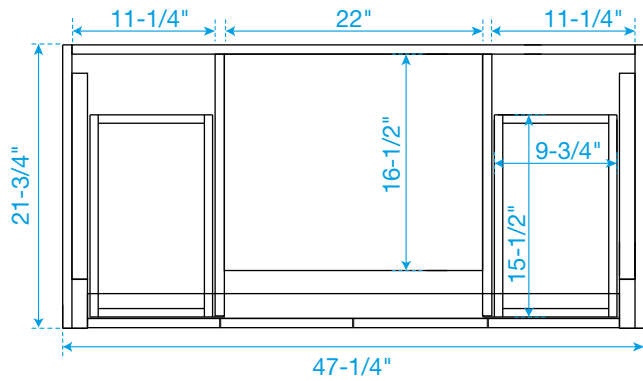
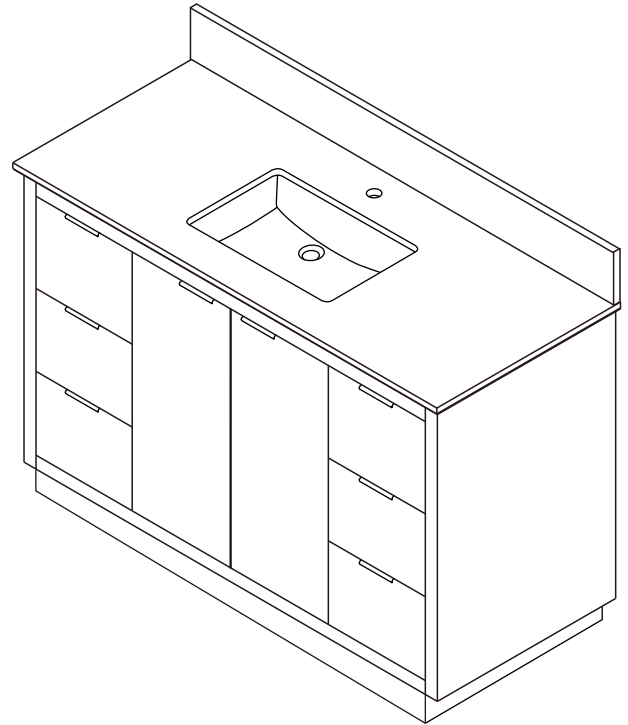

\*Note: All measurements are  $\pm 1/4"$ .

WC-2828-48-SGL  
Quartz