

# WYNDHAM COLLECTION

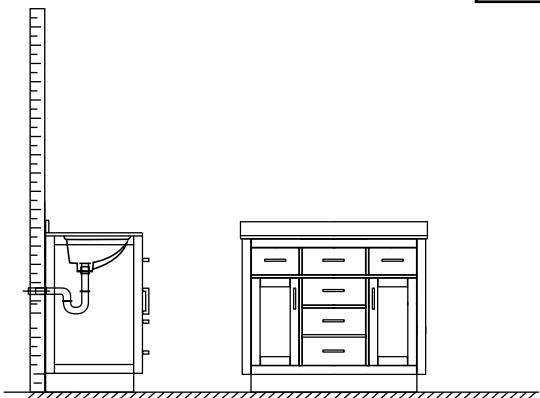

- Prior to installation please check received items against the "Packing List". Please report any missing items to your retailer immediately.
- Protect all surfaces from sharp objects, high heat sources, direct prolonged sunlight and chemical hazards.
- Professional installation recommended.

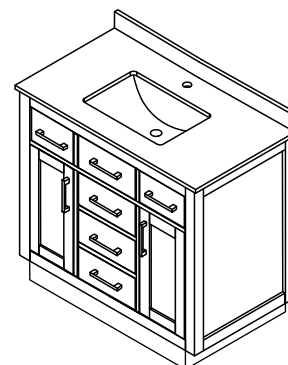

## PACKING LIST

(Not all components may be included, depending upon your purchase)

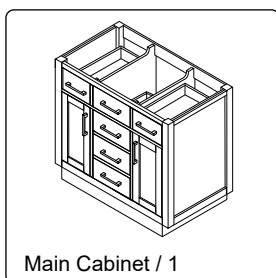
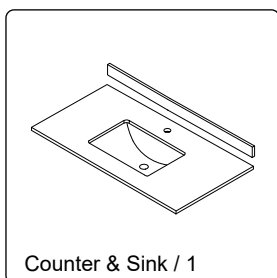

## HOW TO ADJUST HINGES (if required)

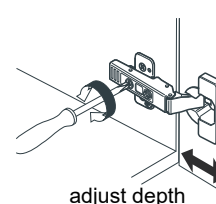
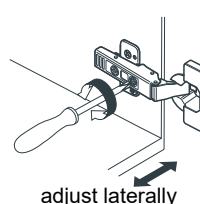
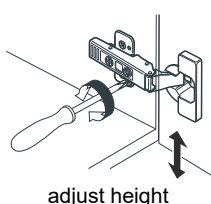
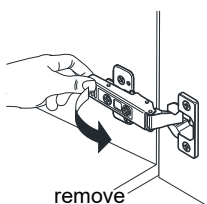
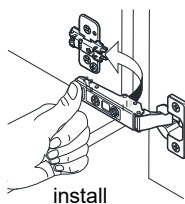

## REQUIRED TOOLS NOT IN BOX

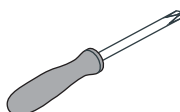
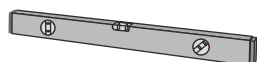

# WC-2626-42-SGL Installation Guide

# WYNDHAM COLLECTION

## INSTALLATION INSTRUCTIONS

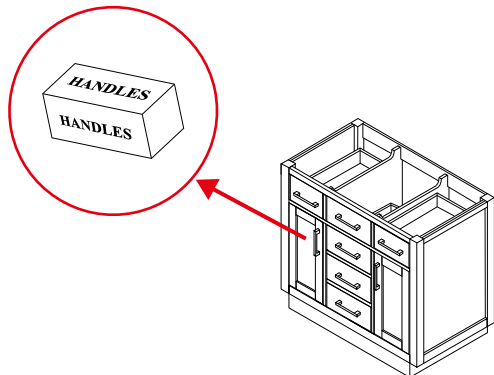

- ① The handles are safely stored for transport in a box inside of the cabinet. Look inside the vanity for the box with your handles.

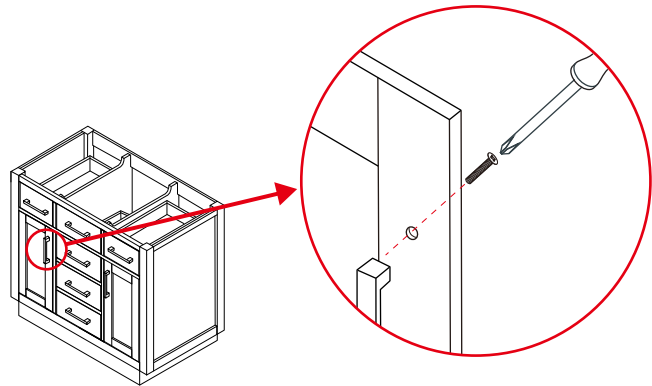

- ② Unpack the handles and install them on the vanity. Do not over tighten when attaching.

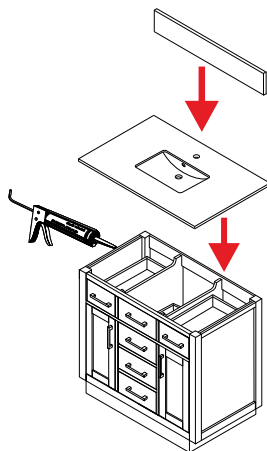

- ③ Install the counter. Seal around the top of the cabinet with clear silicone sealant. Do not over apply. Allow to dry 24 hours for proper curing.

WC-2626-42-SGL  
Installation Guide