

# WYNDHAM COLLECTION

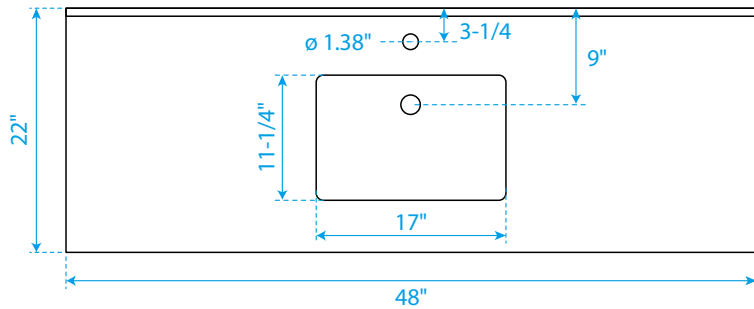

TOP VIEW OF VANITY CABINET

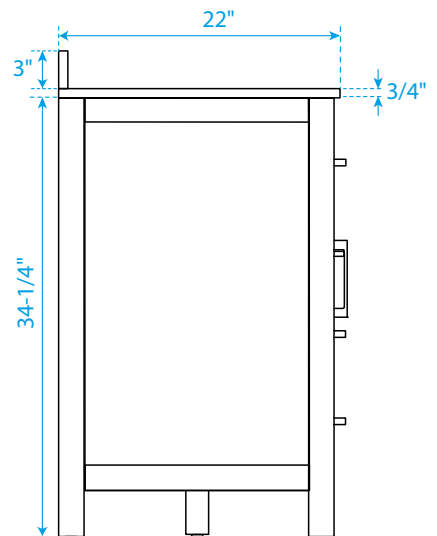
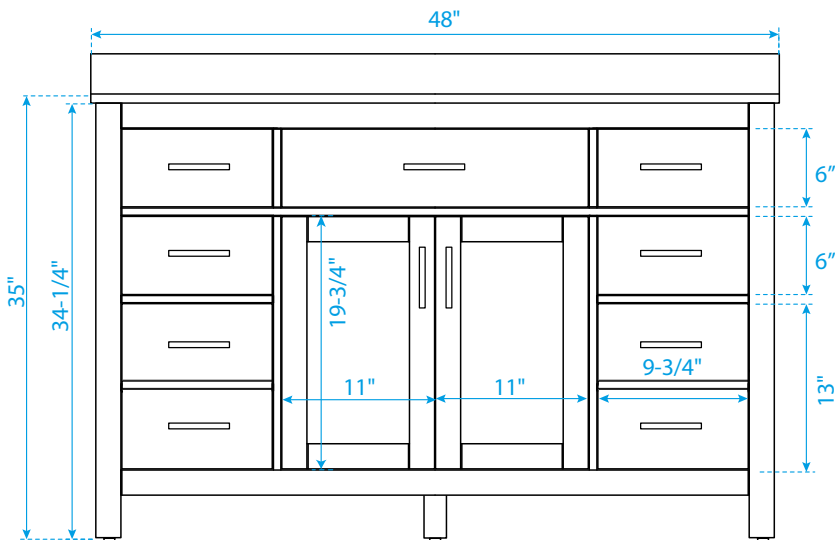
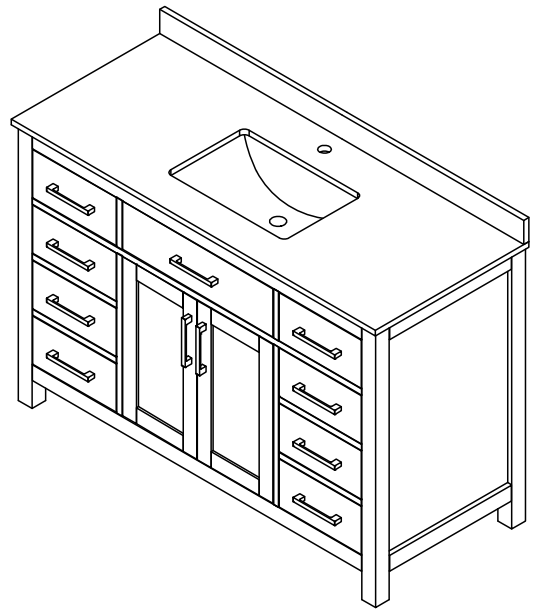
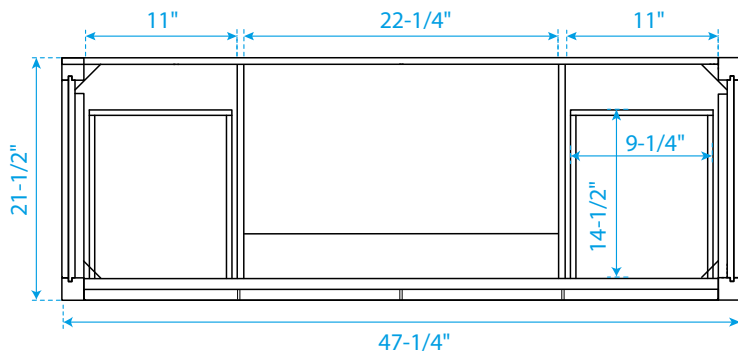

\*Note: All measurements are  $\pm 1/4$ ".

## WC-2424-48-SGL