

WYNDHAM COLLECTION

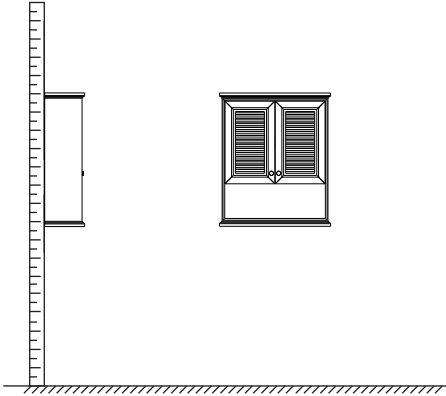

- Prior to installation please check received items against the "Packing List". Please report any missing items to your retailer immediately.
- Protect all surfaces from sharp objects, high heat sources, direct prolonged sunlight and chemical hazards.
- Professional installation recommended.

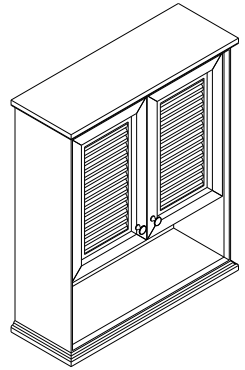

PACKING LIST

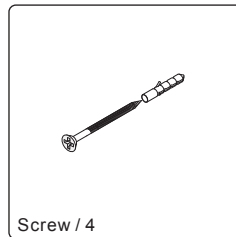
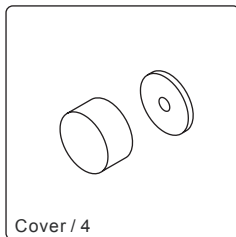
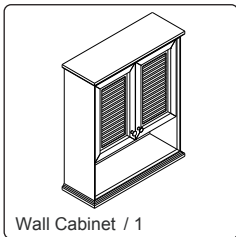

INSTALLATION AND ADJUSTMENT OF HINGES (if required)

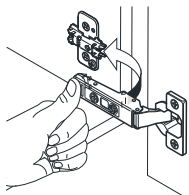

install

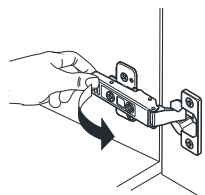

remove

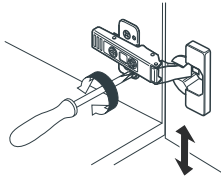

adjust height

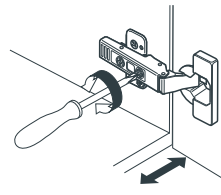

adjust laterally

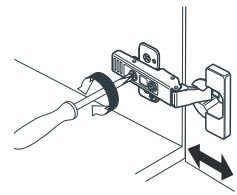

adjust depth

REQUIRED TOOLS NOT IN BOX

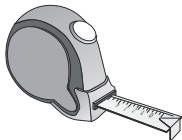

Tape measure



Pencil

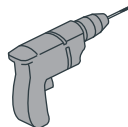

Electric Drill

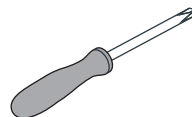

Phillips Screwdriver

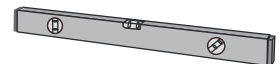

Spirit Level

INSTALLATION INSTRUCTIONS

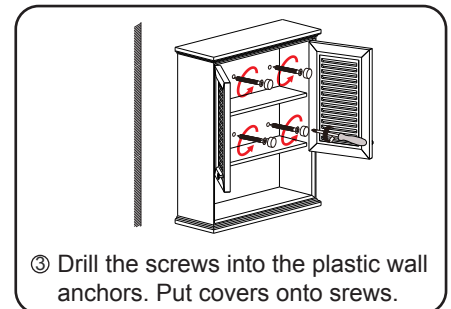
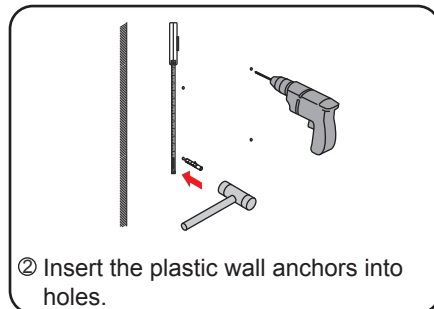
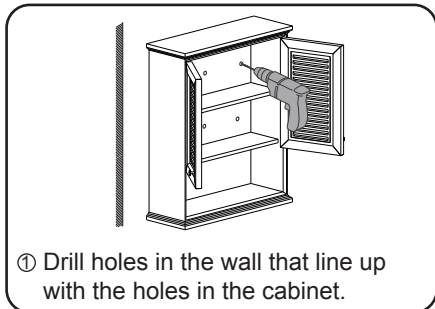

WC-2121-WC Installation Guide