

# WYNDHAM COLLECTION

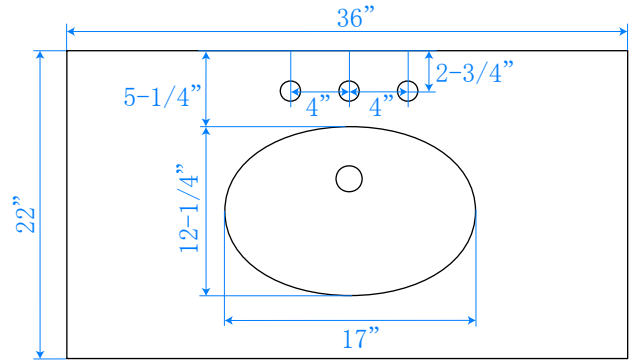

TOP VIEW OF VANITY CABINET

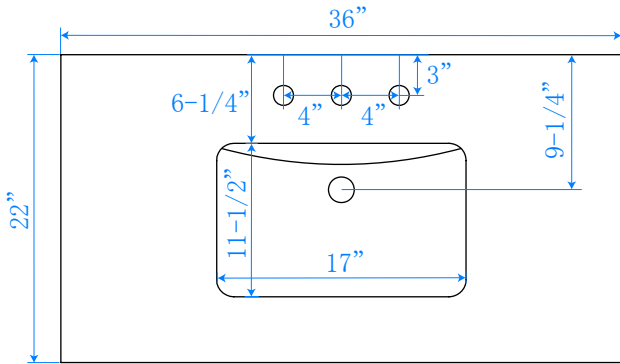
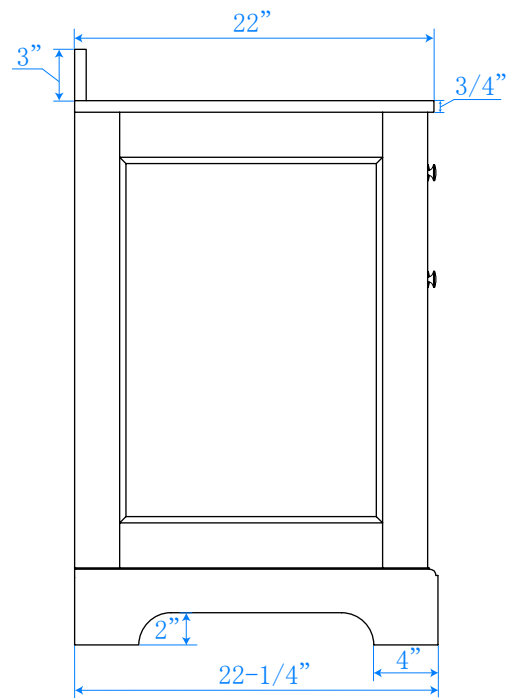
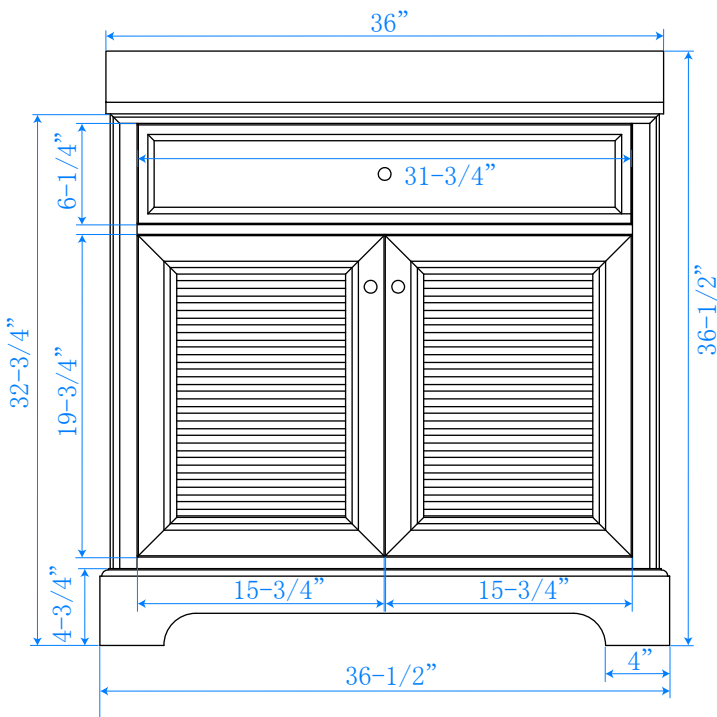
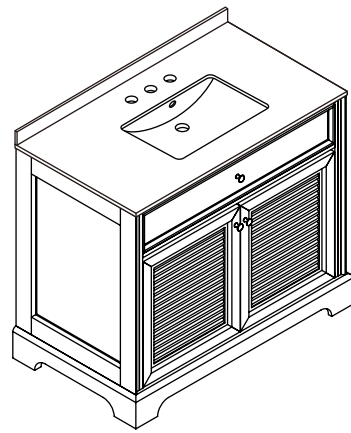
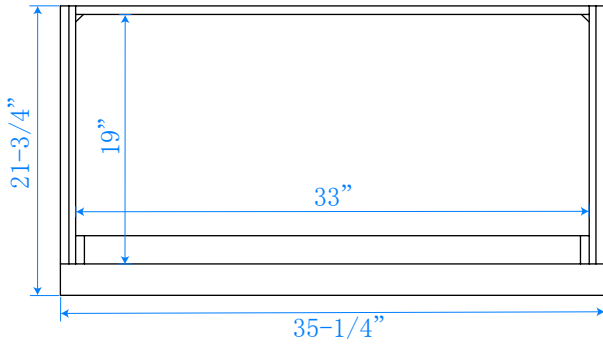

\*Note: All Measurements are  $\pm 1/4$ "

WC-2121-36