

WYNDHAM COLLECTION

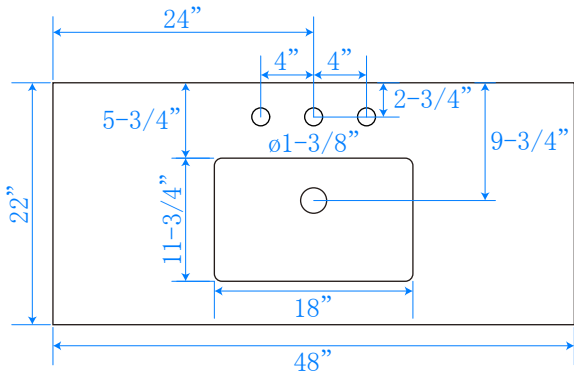

TOP VIEW OF VANITY CABINET

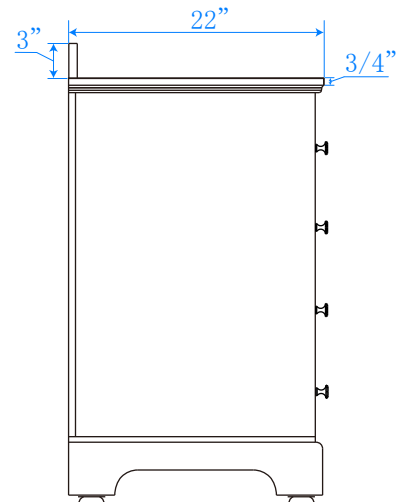
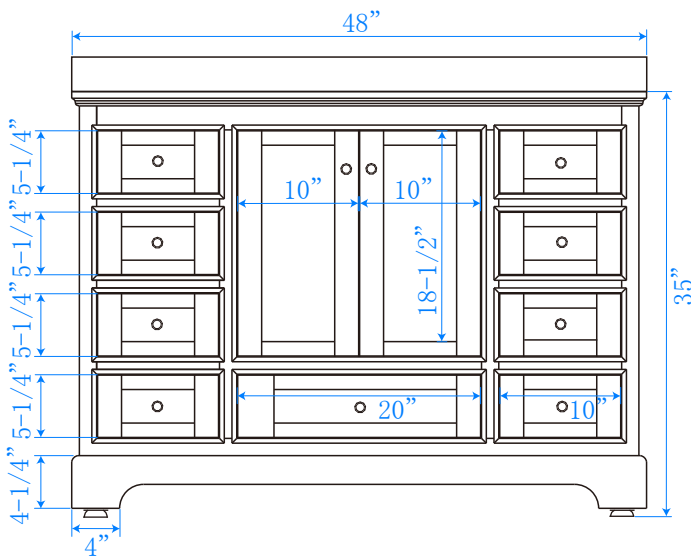
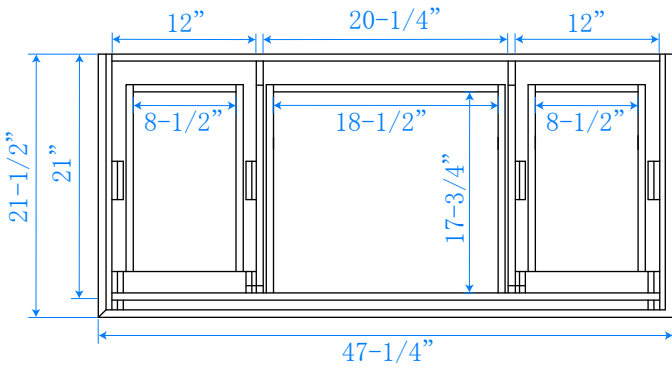
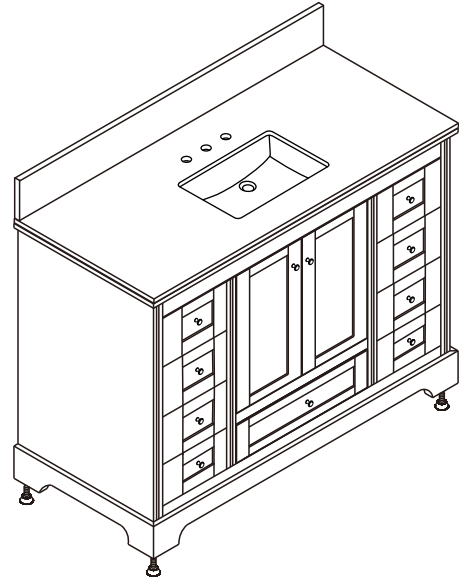

*Note: All Measurements are $\pm 1/4$ "

WC-2020-48-SGL
Quartz