

# WYNDHAM COLLECTION

- Prior to installation please check received items against the "Packing List". Please report any missing items to your retailer immediately.
- Protect all surfaces from sharp objects, high heat sources, direct prolonged sunlight and chemical hazards.
- Professional installation recommended.

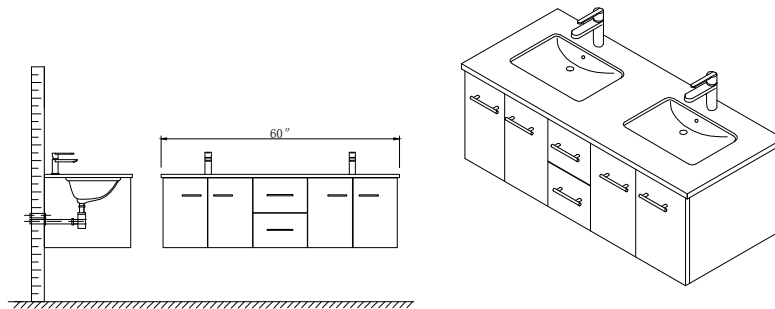

## PACKING LIST

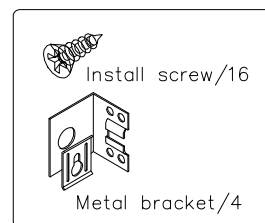
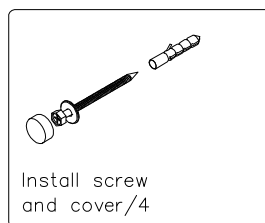
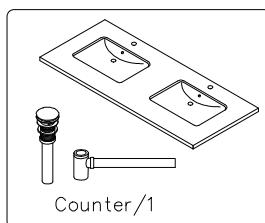
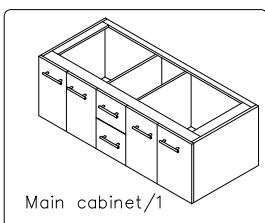

## INSTALLATION AND ADJUSTMENT OF HINGES

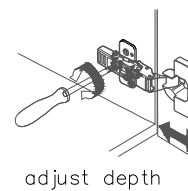
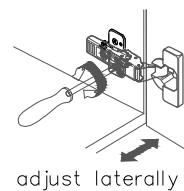
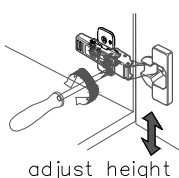
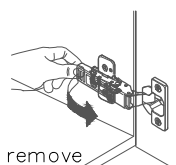
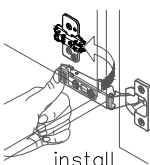

## REQUIRED TOOLS NOT IN BOX

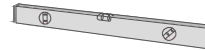
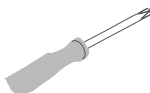
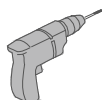
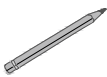
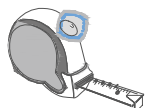

## INSTALLATION INSTRUCTIONS

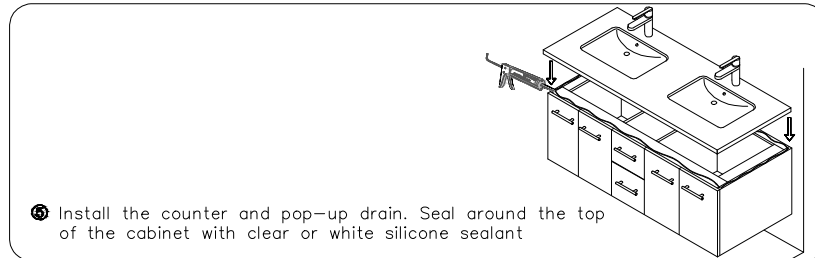
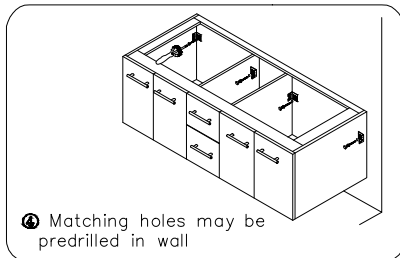
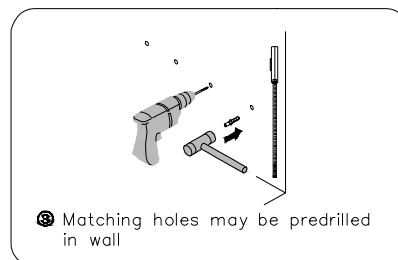
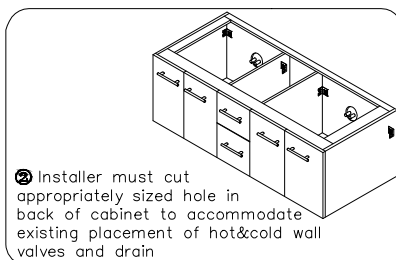
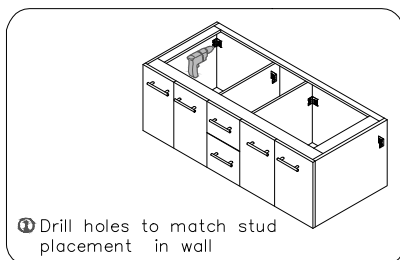

WC-WHE009-60-DBL  
Installation Guide