

WYNDHAM COLLECTION

- Prior to installation please check received items against the "Packing List". Please report any missing items to your retailer immediately.
- Protect all surfaces from sharp objects, high heat sources, direct prolonged sunlight and chemical hazards.
- Professional installation recommended.

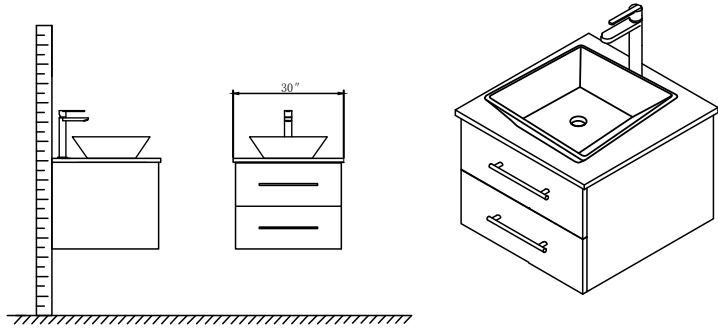

PACKING LIST

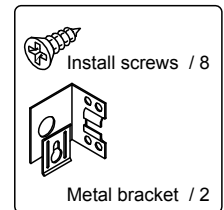
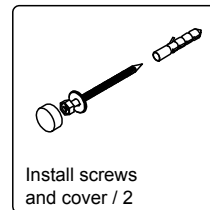
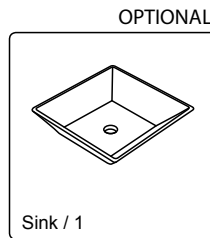
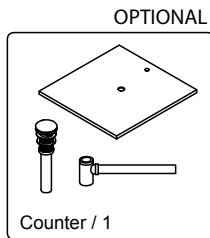
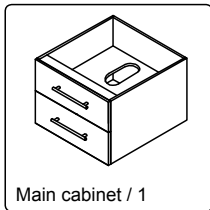

INSTALLATION AND ADJUSTMENT OF HINGES

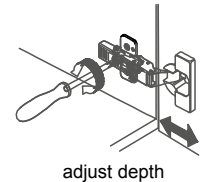
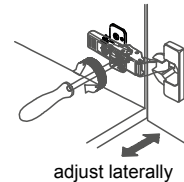
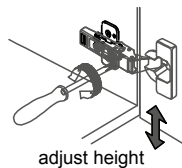
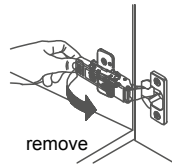
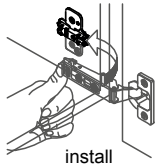

REQUIRED TOOLS NOT IN BOX

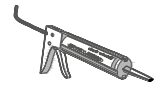
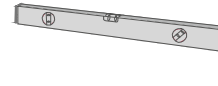
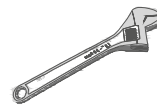
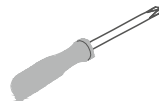
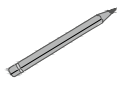
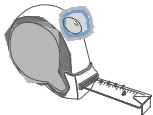

INSTALLATION INSTRUCTIONS

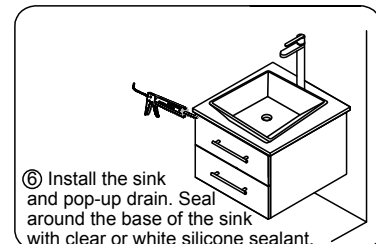
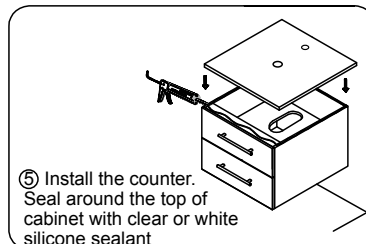
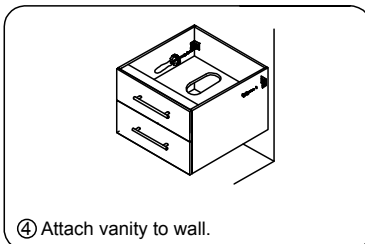
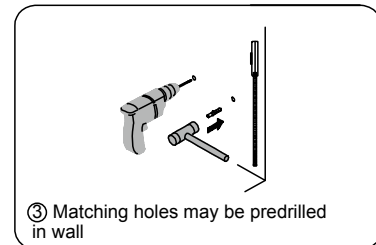
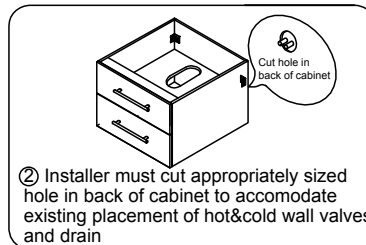
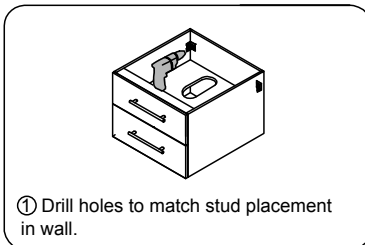

WC-WHE009-30
Overmount Installation Guide