

WYNDHAM COLLECTION

- Prior to installation please check received items against the "Packing List". Please report any missing items to your retailer immediately.
- Protect all surfaces from sharp objects, high heat sources, direct prolonged sunlight and chemical hazards.
- Professional installation recommended.

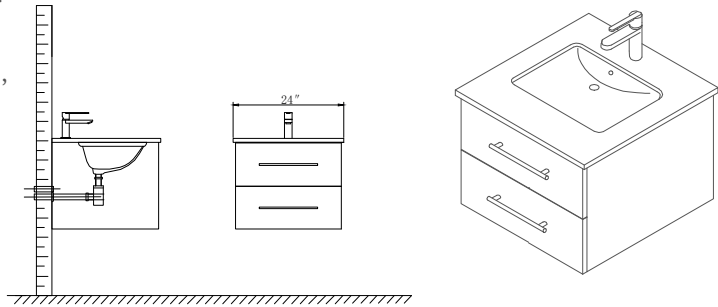

PACKING LIST

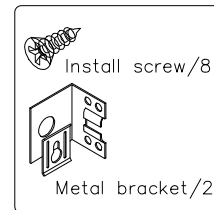
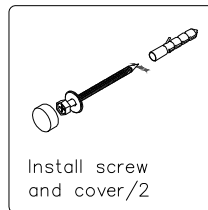
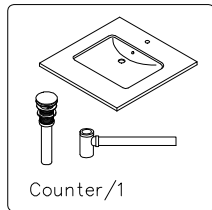
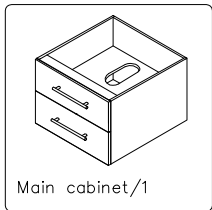

INSTALLATION AND ADJUSTMENT OF HINGES

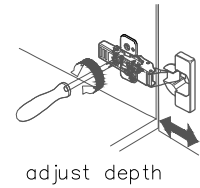
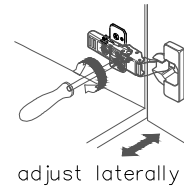
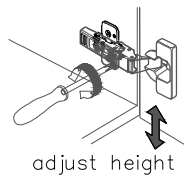
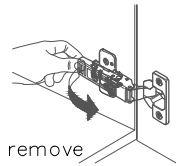
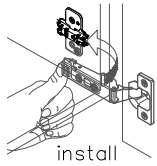

REQUIRED TOOLS NOT IN BOX

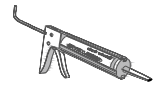
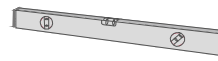
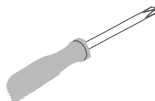
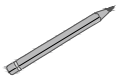
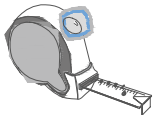

Tape measure

Pencil

Electric Drill

Phillips Screwdriver

Adjustable Wrench

Spirit Level

Silicone sealant

INSTALLATION INSTRUCTIONS

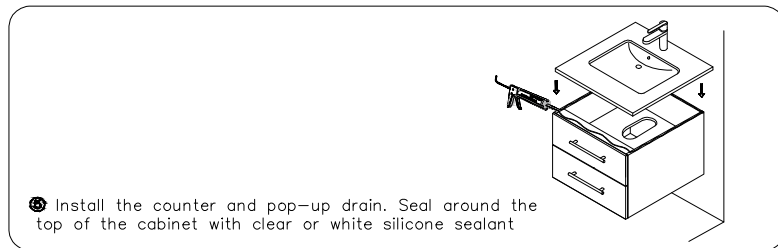
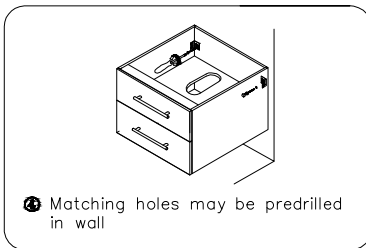
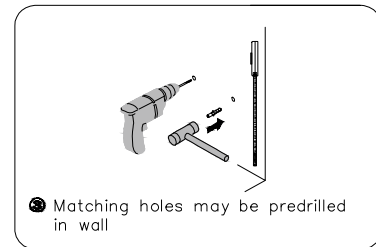
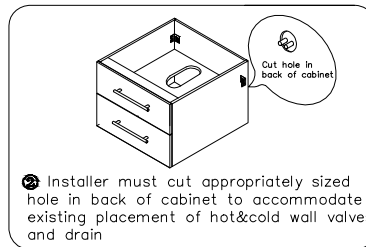
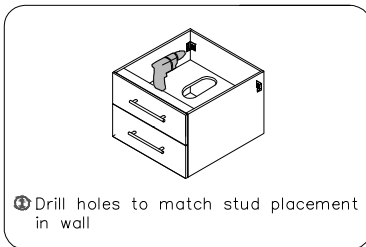

WC-WHE009-24
Installation Guide