

WYNDHAM COLLECTION

- Prior to installation, please check recieved items against the "Parts List". Please report any missing items to your retailer immediately.
- Protect all surfaces from sharp objects, high heat sources, direct prolonged sunlight and chemical hazards.
- Professional installation recommended.

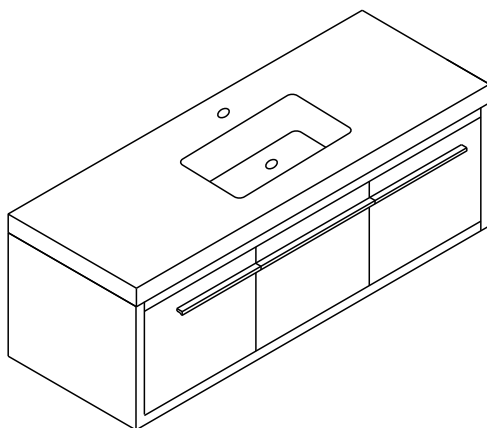

Tools List (Tools not included)

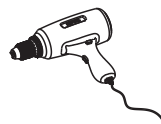

Electric drill



Silicone



Tape measure



Drill bit
(Ø8)



Pencil

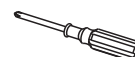

Screwdriver

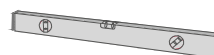

Spirit Level

Parts List



12B



12C

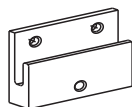

4D

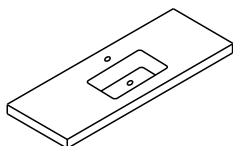

1 Integrated Countertop and Sink



2 per mirror



2 per mirror

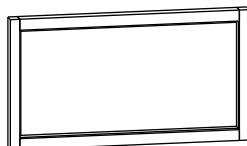

1 or 2 Mirrors

- 1 Mark the position of the screw holes on the wall by measuring the space between the centers of the mounting brackets on the back of the vanity. Vertical position (X) is decided by the purchaser - remember to mark low enough to accommodate the sink on the top of the vanity counter or it will be too high when installed. Use a spirit level to ensure the screws holes are horizontal.

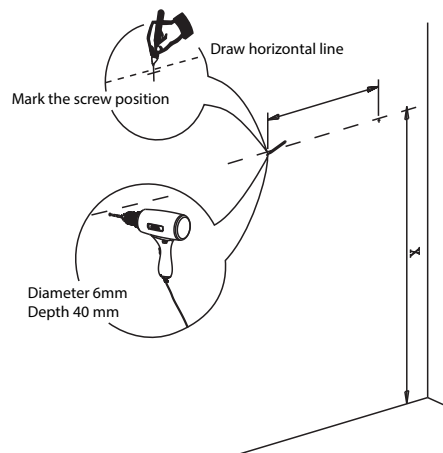

WC-R4300-72-SGL
RESIN INSTALLATION GUIDE

WYNDHAM COLLECTION

2 Insert the anchor into the screw hole for reinforcement.

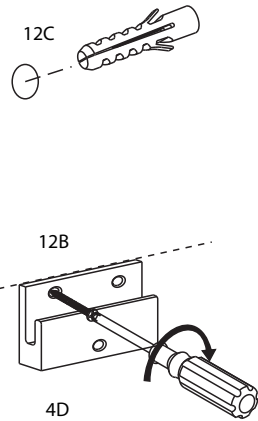

3 Attach vanity to wall by lowering onto the mounting brackets

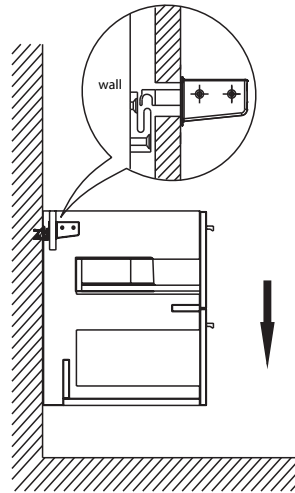

4 Adjust the mounting attachment as required

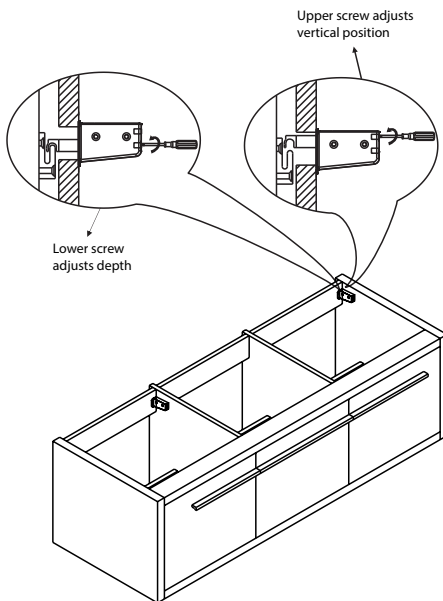

5 Adjust hinges as required.

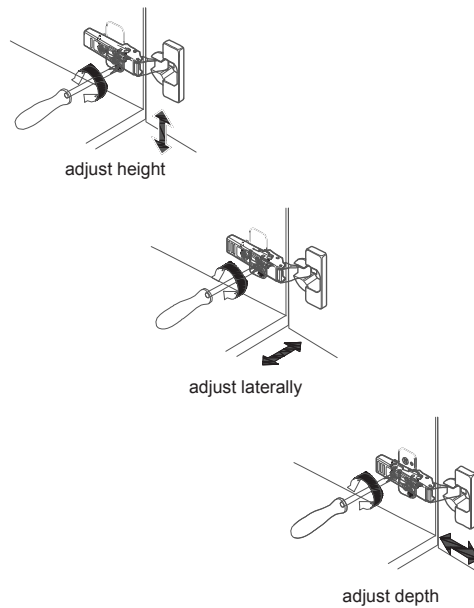

WC-R4300-72-SGL
RESIN INSTALLATION GUIDE

WYNDHAM COLLECTION

- 6** Use a spirit level to ensure the vanity is level left to right. Adjust if needed.

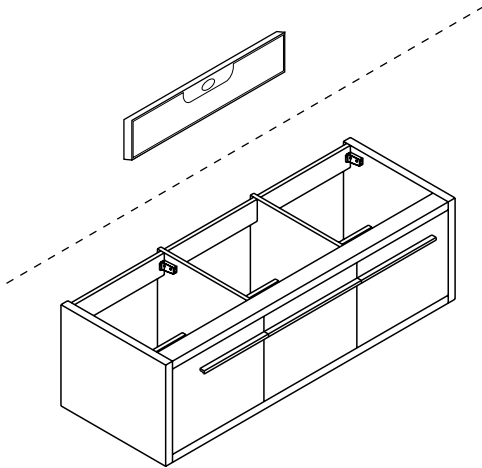

- 7** Use a spirit level to ensure the vanity is front to back. Adjust if needed.

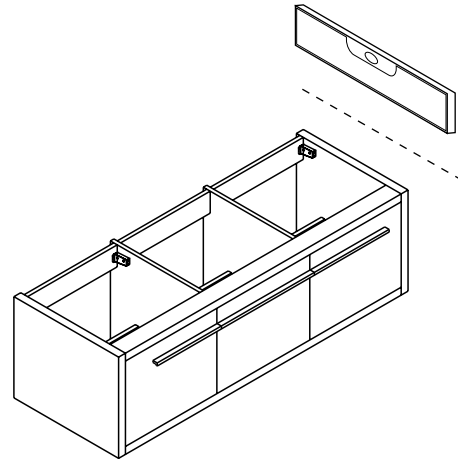

- 8** Attach counter to cabinet with silicone sealant applied to top of front and side cabinet edges. Do not over-apply. Allow to dry for 24 hours for proper curing.

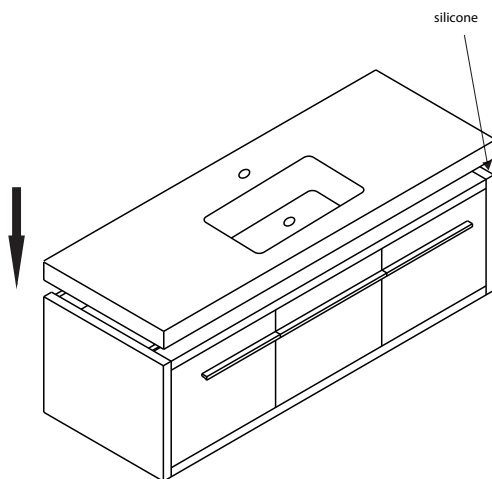

- 9** Licensed professional installation is recommended. These instructions are for mounting into studs or other in-wall reinforcement, drywall alone is not sufficient to support wall-hung vanities. Other installation techniques may require a licensed professional.

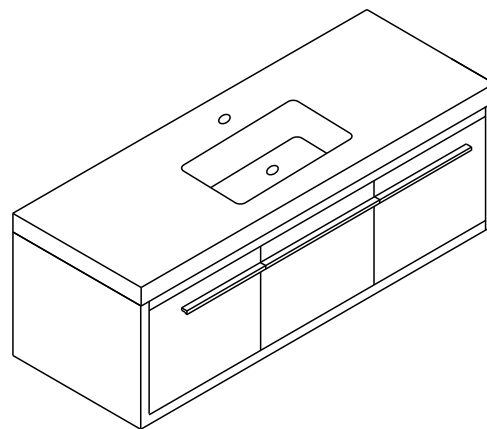

WC-R4300-72-SGL
RESIN INSTALLATION GUIDE

WYNDHAM COLLECTION

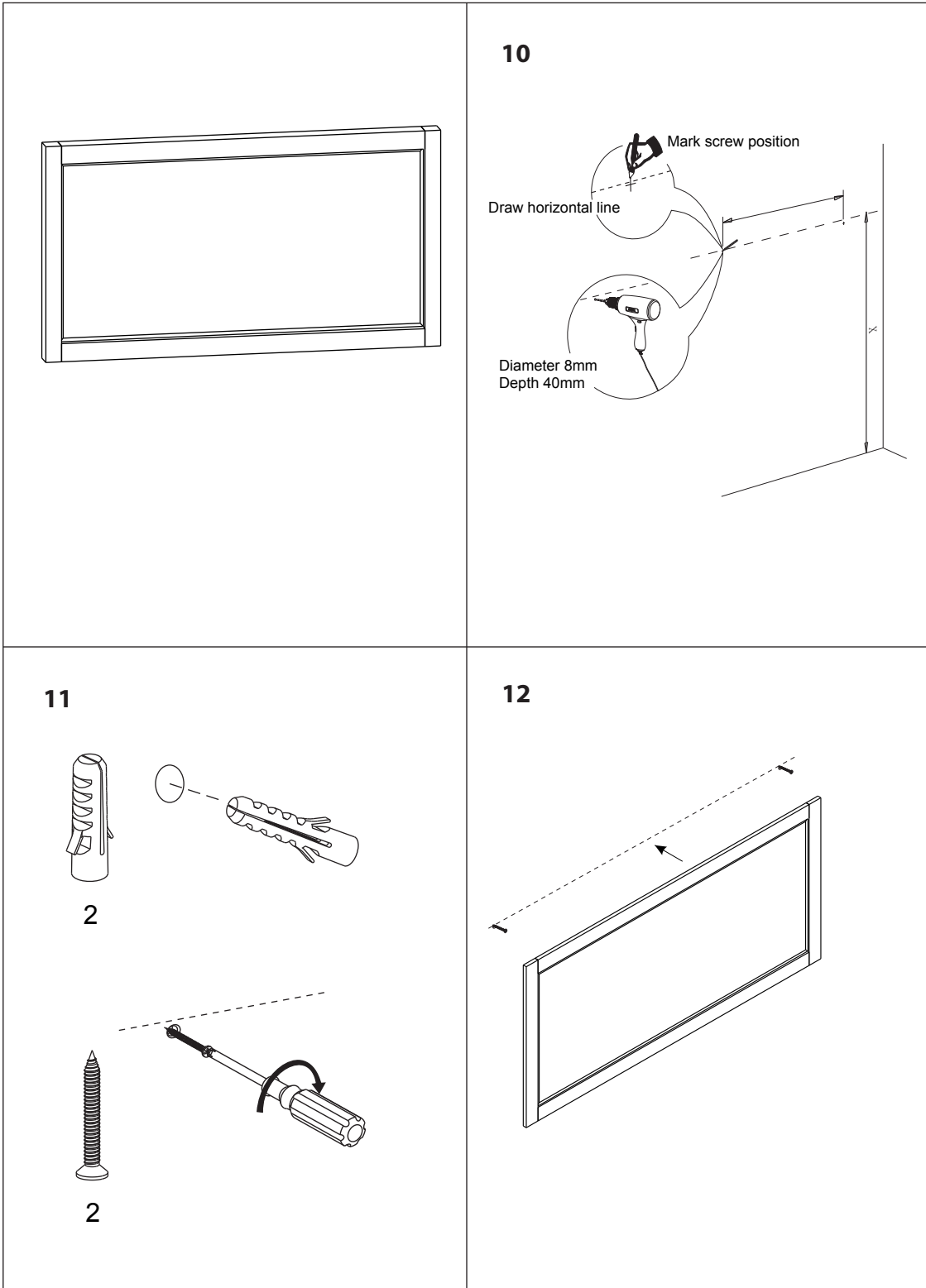

WC-R4300-72-SGL
RESIN INSTALLATION GUIDE