

WYNDHAM COLLECTION

- Prior to installation please check received items against the "Packing List". Please report any missing items to your retailer immediately.
- Protect all surfaces from sharp objects, high heat sources, direct prolonged sunlight and chemical hazards.
- Professional installation recommended.

PACKING LIST

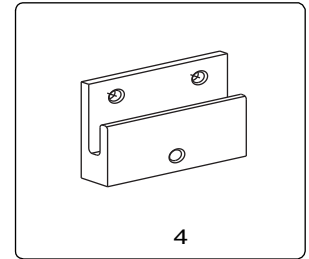
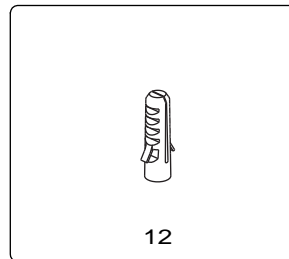
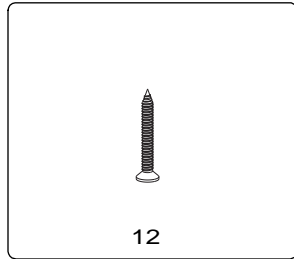
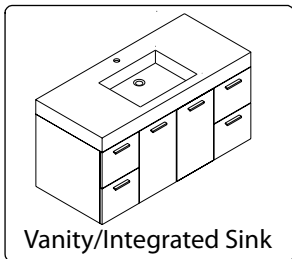

REQUIRED TOOLS NOT IN BOX

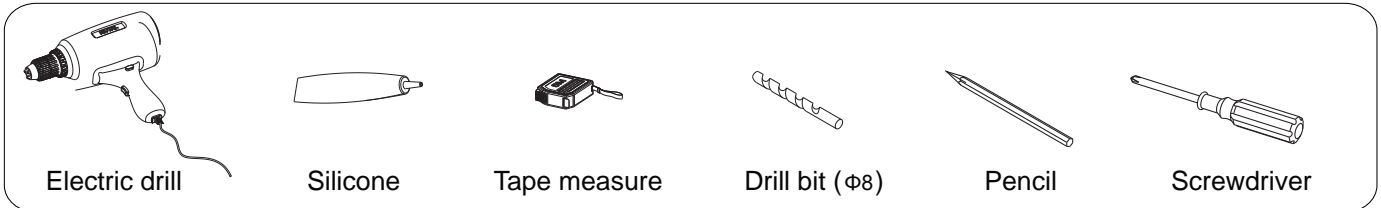

INSTALLATION INSTRUCTIONS

- 1 Mark the position of the screw holes on the wall by measuring the space between the centers of the mounting brackets on the back of the vanity. Vertical position (X) is decided by the purchaser. Remember to mark low enough to accommodate the sink on the top of the vanity counter or it will be too high when installed. Use a spirit level to ensure the screw holes are horizontal.

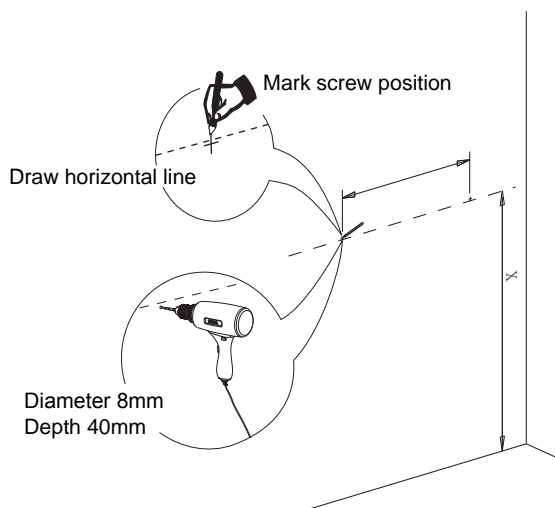

- 2 Insert the anchor into the screw hole for reinforcement.

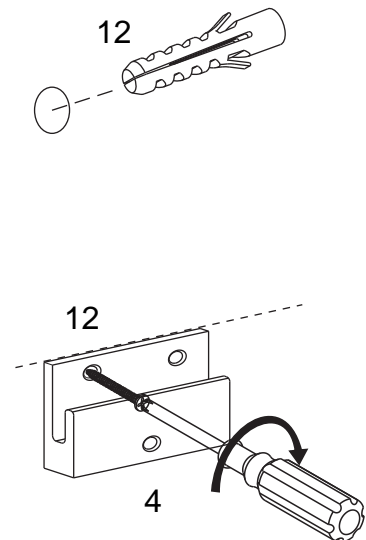

WC-R4100-60-RESIN
INSTALLATION

3 Attach vanity to wall by lowering onto the mounting brackets

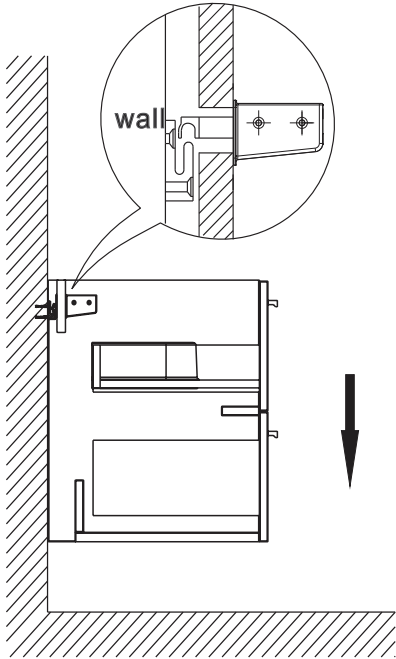

4 Adjust the mounting attachment as required

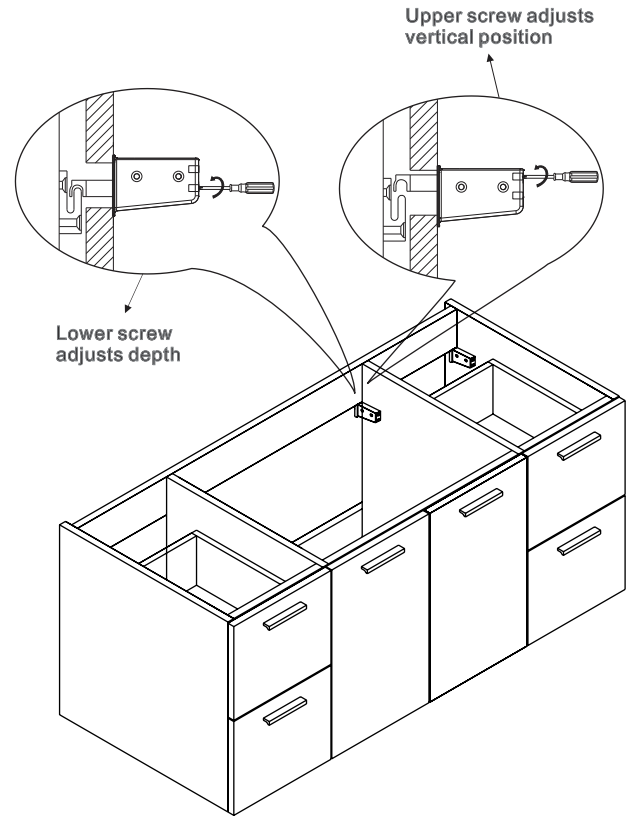

5 Attach counter to cabinet with silicone sealant applied to top of front and side cabinet edges. Do not over-apply. Allow to dry for 24 hours for proper curing.

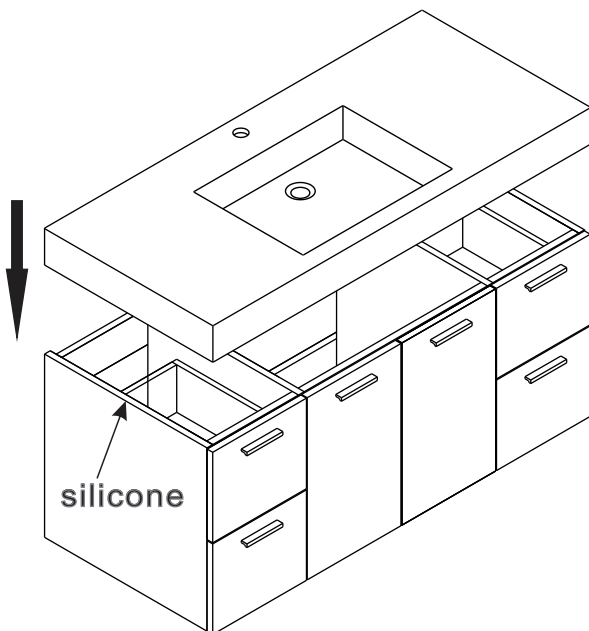

6 Licensed professional installation is recommended. These instructions are for mounting into studs or other in-wall reinforcement, drywall alone is not sufficient to support wall-hung vanities. Other installation techniques may require a licensed professional.

