

WYNDHAM COLLECTION

Exterior Size - 71-1/2"L x 31-1/4"W x 23"H
Depth at Drain - 18"
Drain to Overflow - 14-3/4"
Maximum Fill - 67 Gallons
Note - All Measurements are $\pm 1/2$ "

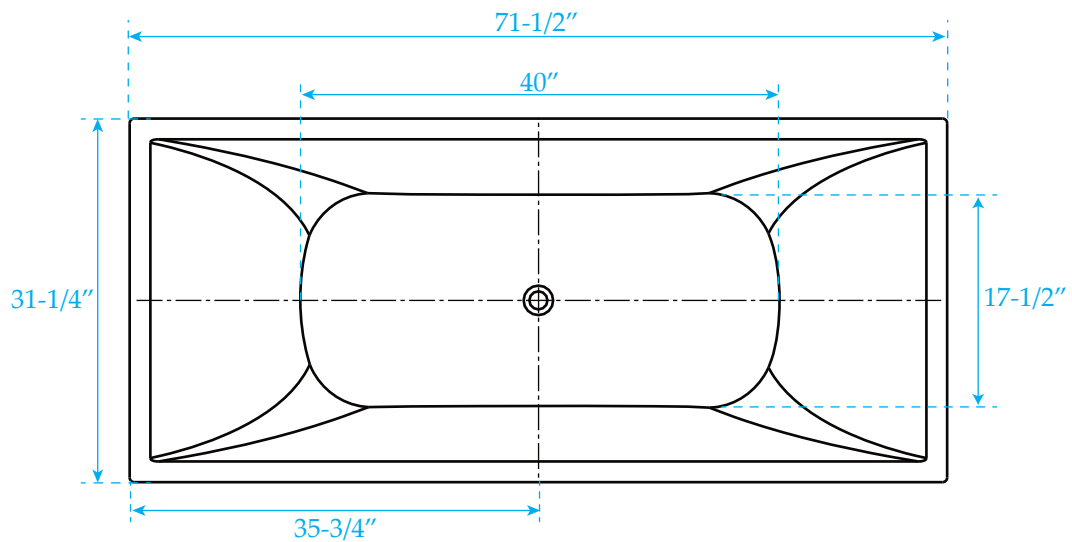
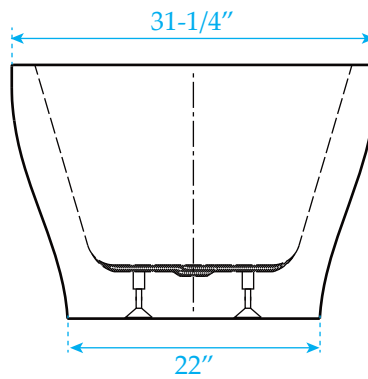
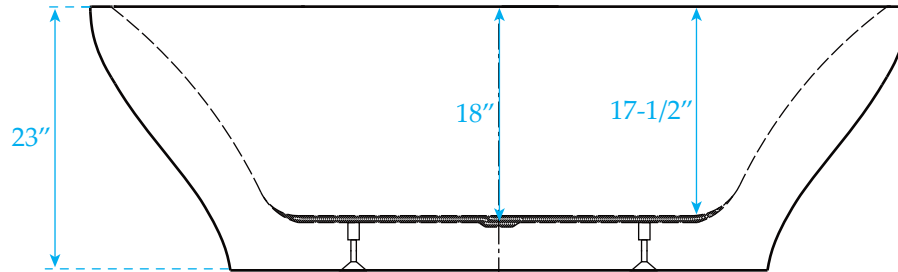

WC-BTK1518-71