

# WYNDHAM COLLECTION

Exterior Size - 59"L x 29-1/2"W x 23-1/2"H  
Interior Size - 56-1/2"L x 26-1/2"W x 18"H  
Depth at Drain - 18-1/2"  
Drain To Overflow - 15"  
Maximum Fill - 66 Gallons  
Note - All Measurements are  $\pm 1/2$ "

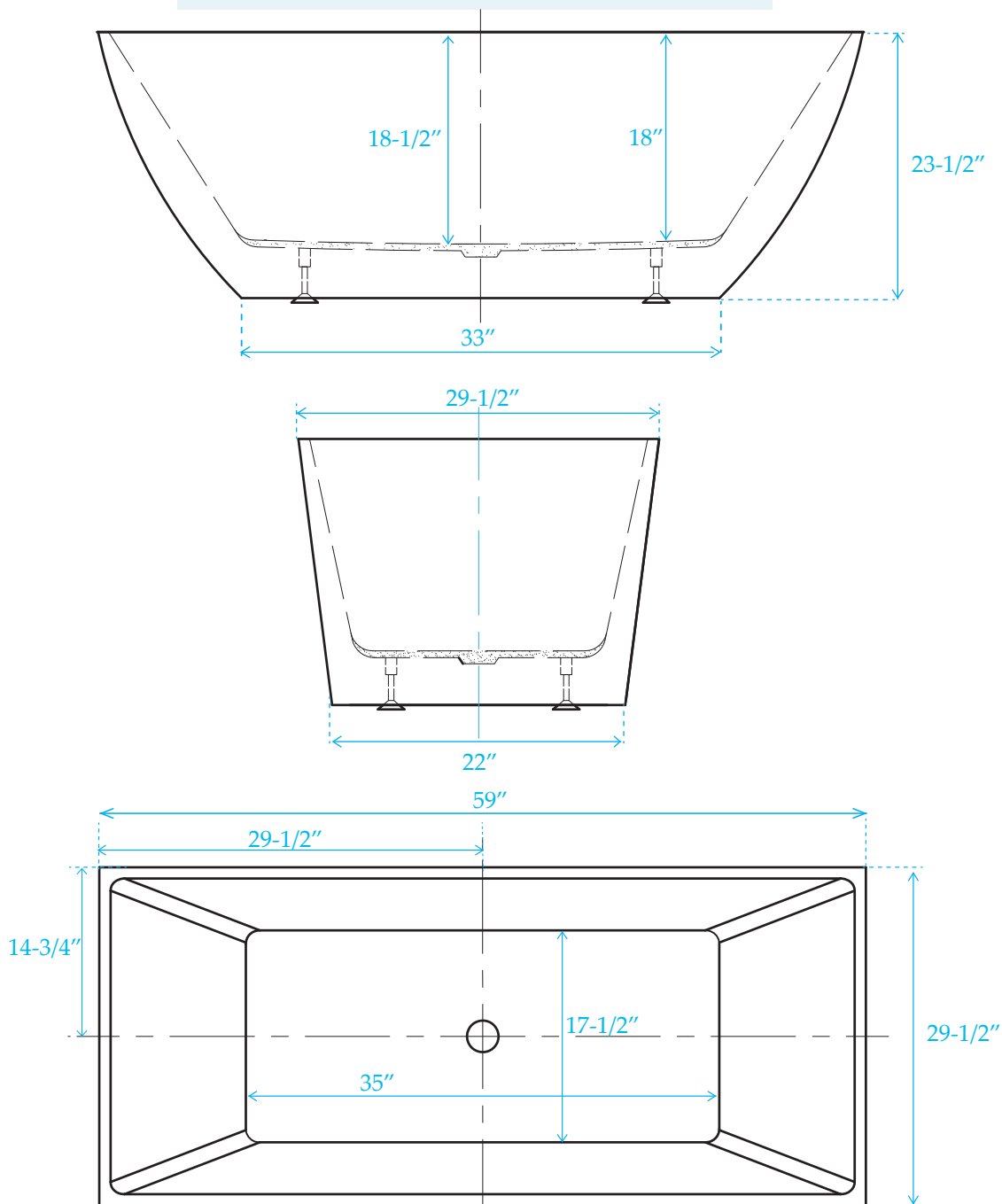

WC-BTK1505-59