

# WYNDHAM COLLECTION

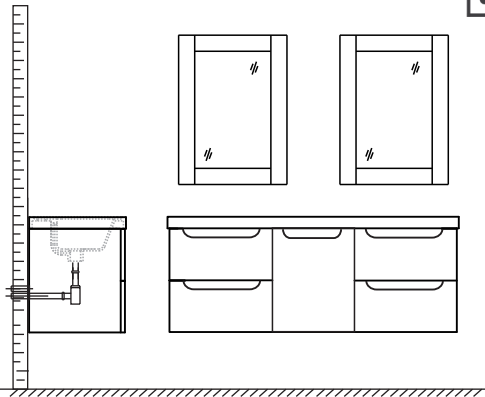
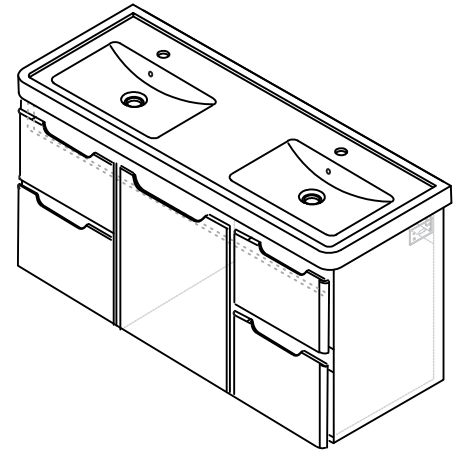

- Prior to installation please check received items against the "Packing List". Please report any missing items to your retailer immediately.
- Protect all surfaces from sharp objects, high heat sources, direct prolonged sunlight and chemical hazards.
- Professional installation recommended.

## PACKING LIST

(Not all components may be included, depending on your purchase)

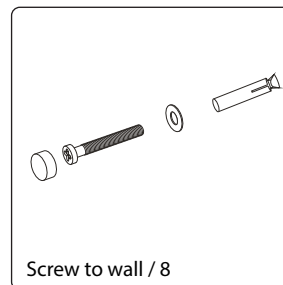
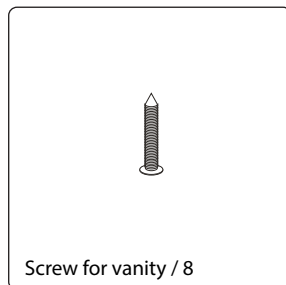
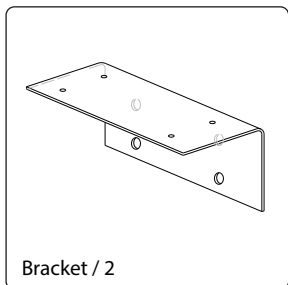
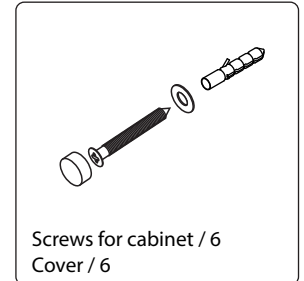
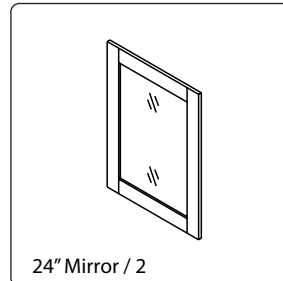
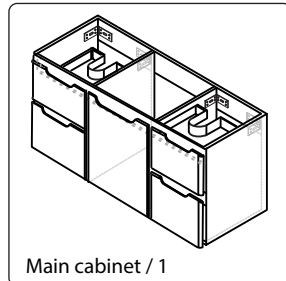
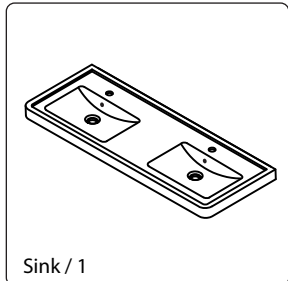

## INSTALLATION AND ADJUSTMENT OF HINGES (if required)

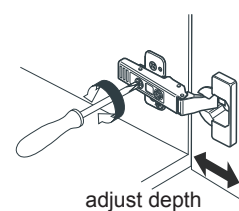
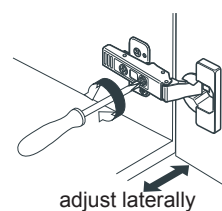
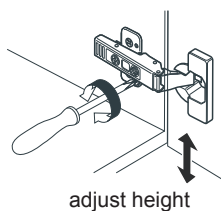
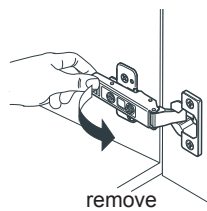
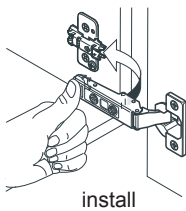

## REQUIRED TOOLS NOT IN BOX

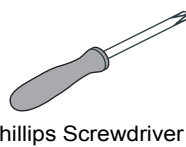
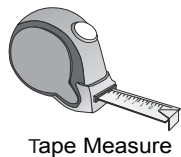

WC-7777-72-DBL  
INSTALLATION-GUIDE

# WYNDHAM COLLECTION

## INSTALLATION INSTRUCTIONS

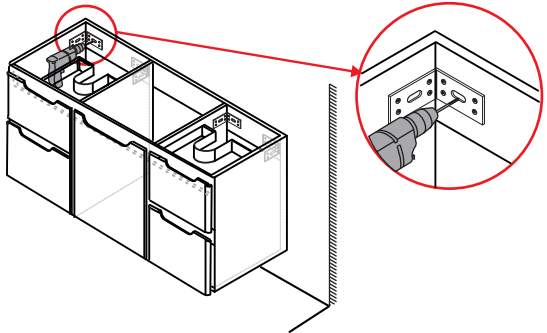

- ① Drill through the hole in the corner bracket on the backboard or as shown. Mark the wall according to the holes at your preferred height and drill holes in the wall.

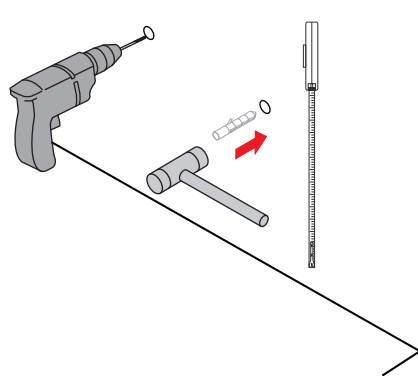

- ② Gently tap the crew anchors into the holes with a hammer.

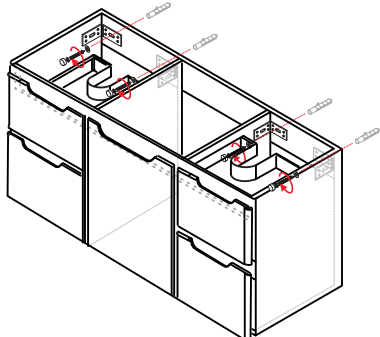

- ③ Fasten cabinet to wall by attaching screws through the bracket holes, and by attaching the lower brackets. Use a spirit level to ensure vanity is leveled.

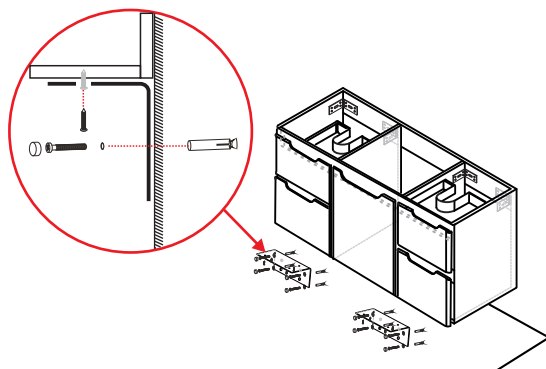

- ④ Mount lower support brackets to wall and bottom of vanity.

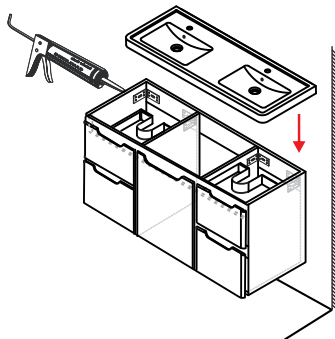

- ⑤ Install the counter. Seal around the top of the cabinet with clear silicone sealant. Do not over apply. Allow to dry for over 24 hours for proper curing.

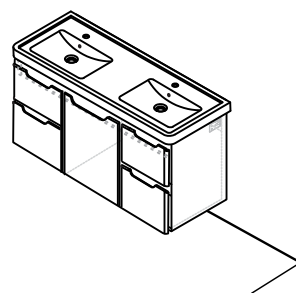

- ⑥ Licensed professional installation recommended. These instructions are for mounting into studs or other in wall reinforcement, drywall alone is not sufficient to support wall hung vanities. Other installation techniques may require a licensed professional.

WC-7777-72-DBL  
INSTALLATION-GUIDE

# WYNDHAM COLLECTION

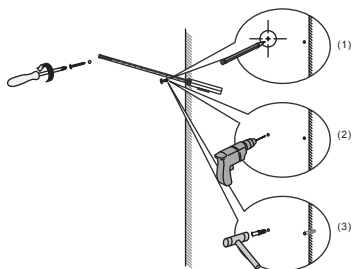

- ⑦ Install the mirror: use a pencil to mark the placement of the screw holes on the wall, drill the holes and insert the plastic wall anchors.

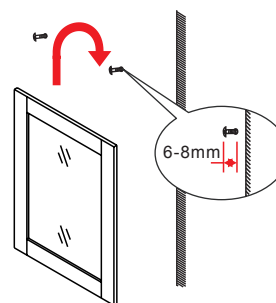

- ⑧ Install the screws into the wall anchors, leaving enough of the screw exposed to hang the mirror - approx. 1/4"-1/2".

WC-7777-72-DBL  
INSTALLATION-GUIDE