

WYNDHAM COLLECTION

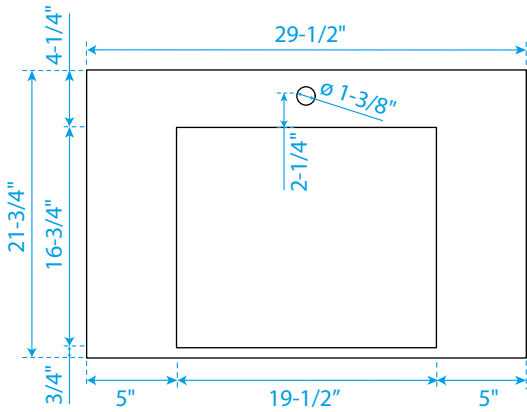

TOP VIEW OF VANITY CABINET

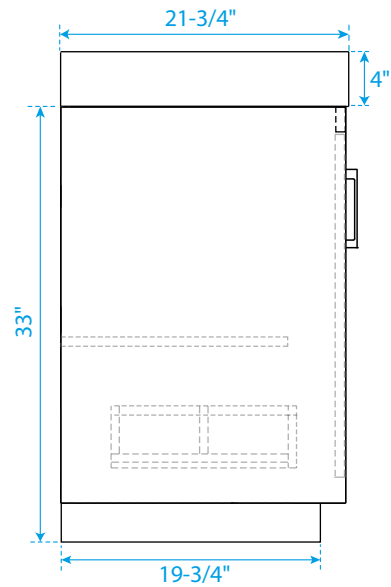
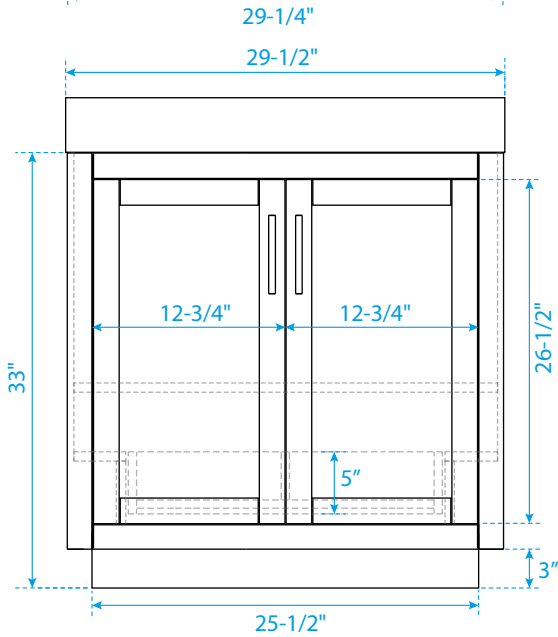
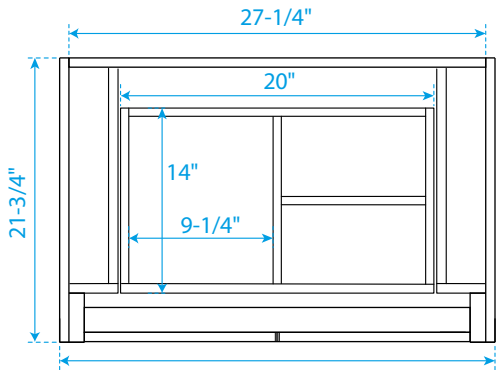
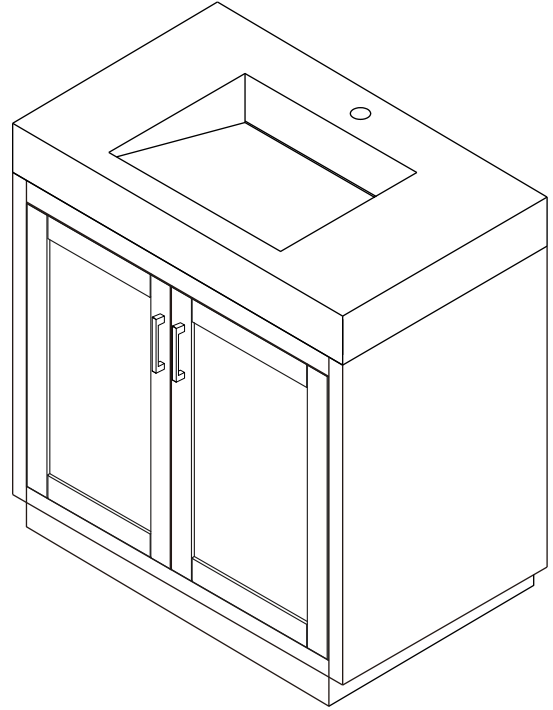

*Note: All measurements are $\pm 1/4"$.

WC-2929-30-SGL
with integrated sinks

WYNDHAM COLLECTION

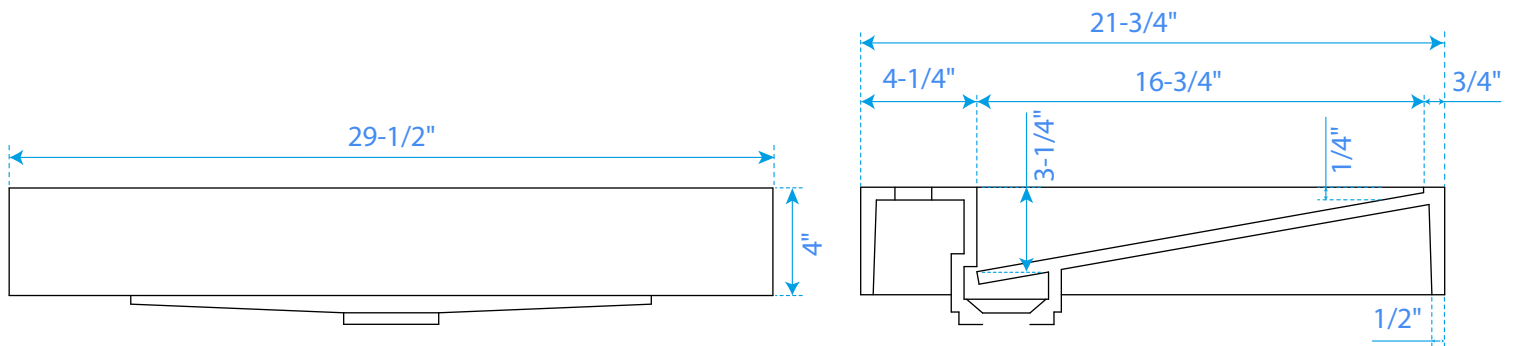
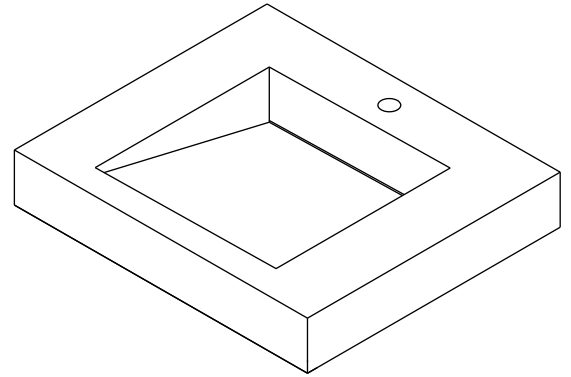
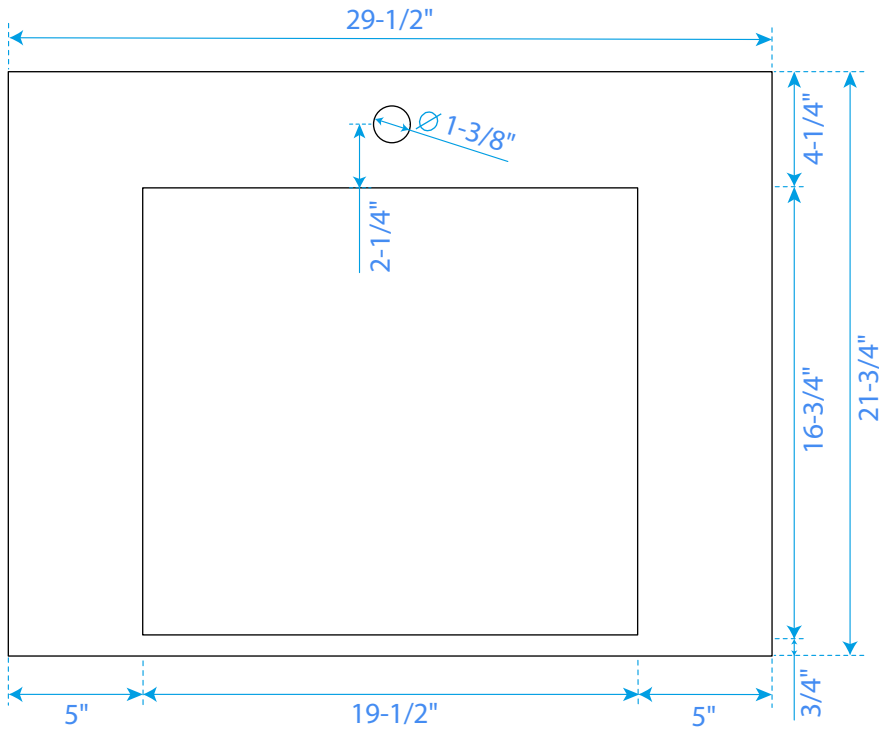

*Note: All measurements are $\pm 1/4"$.

WC-KC4-30-SGL-TOP