

WYNDHAM COLLECTION

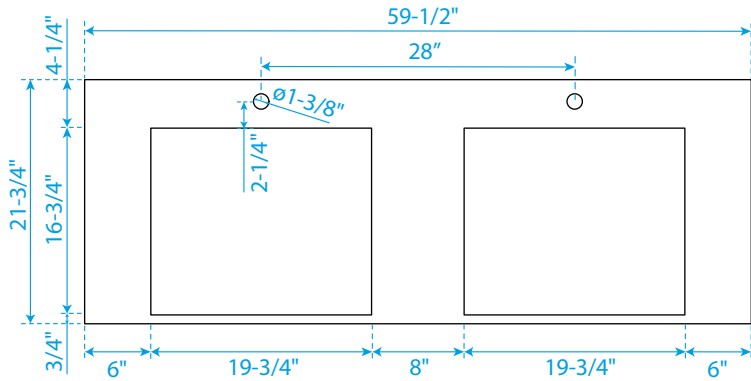

TOP VIEW OF VANITY CABINET

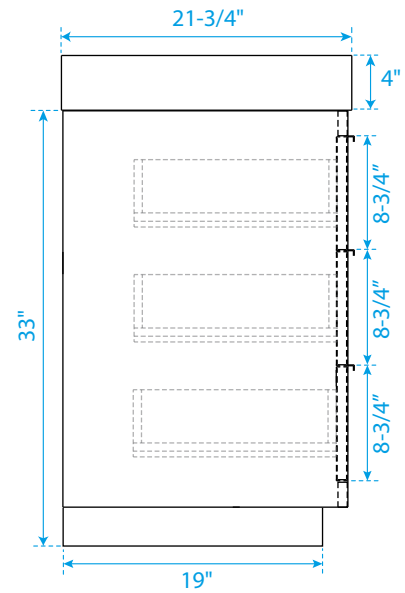
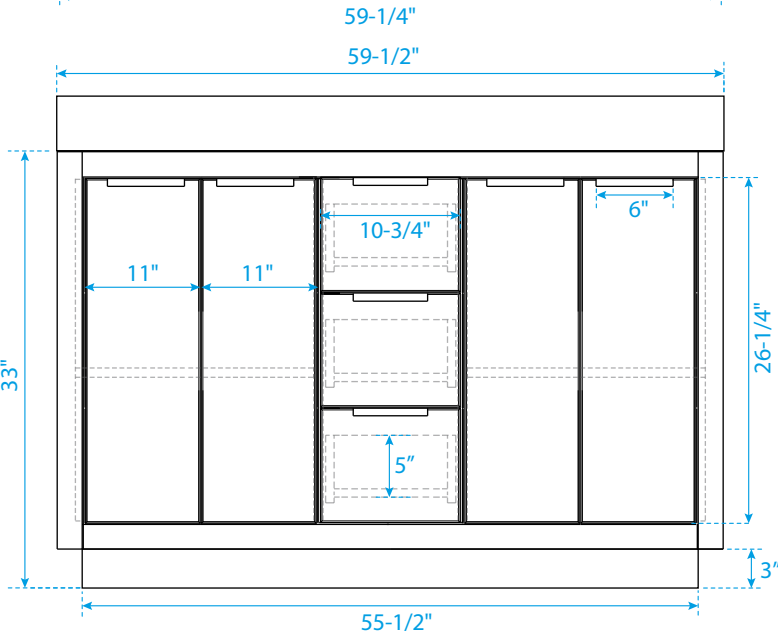
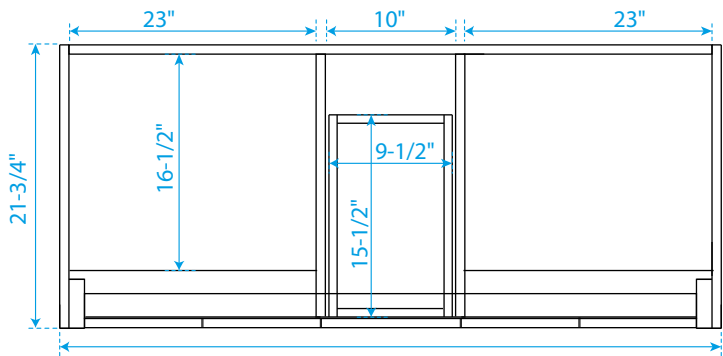
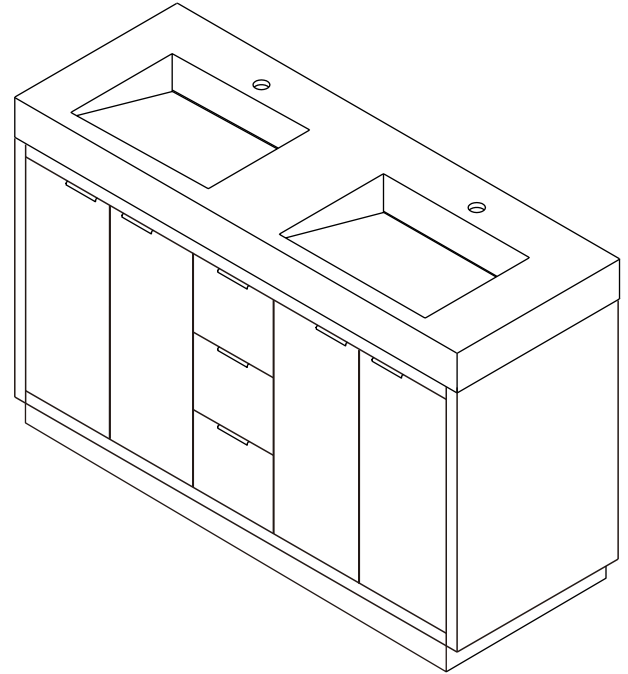

*Note: All measurements are $\pm 1/4"$.

WC-2828-60-DBL
with integrated sinks

WYNDHAM COLLECTION

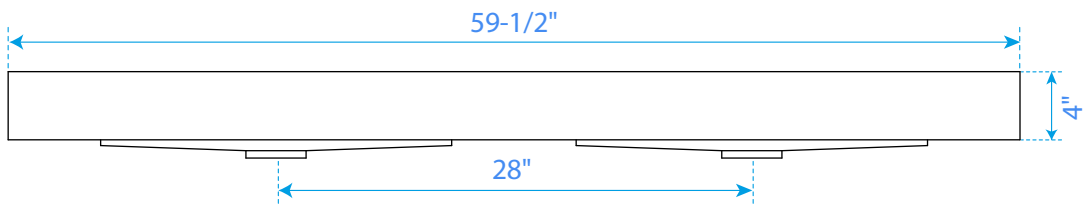
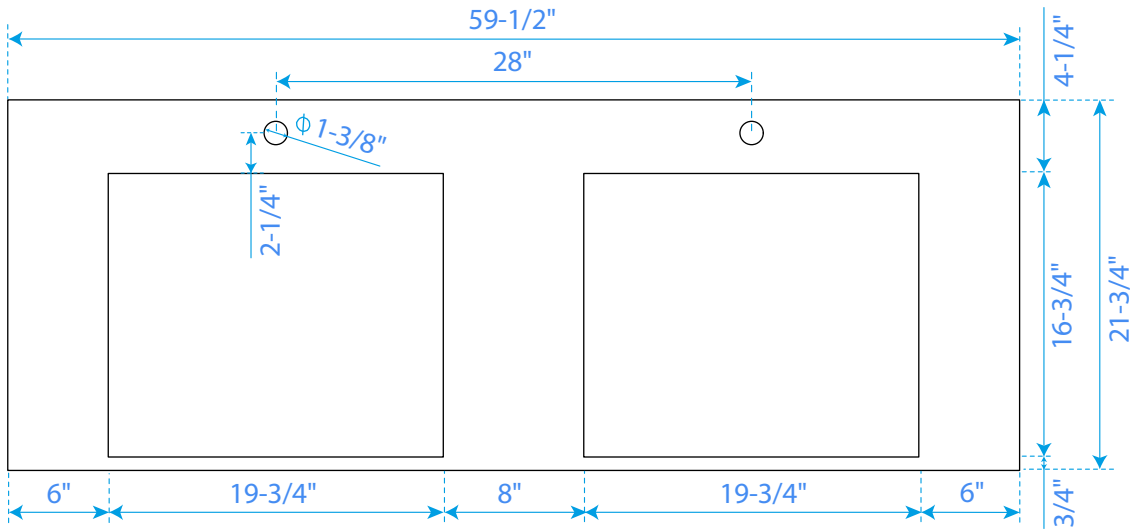
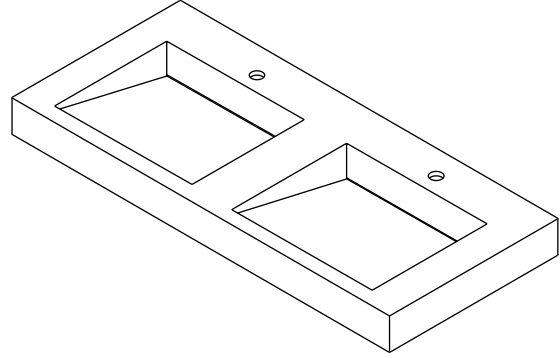
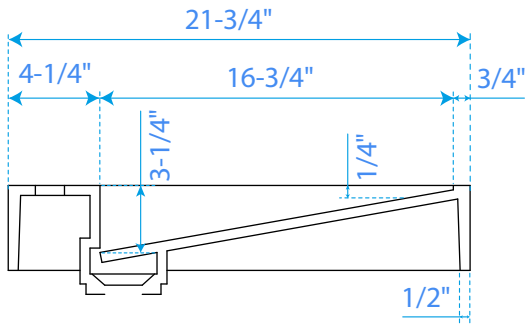

*Note: All measurements are $\pm 1/4"$.

WC-KC4-60-DBL-TOP