

WYNDHAM COLLECTION

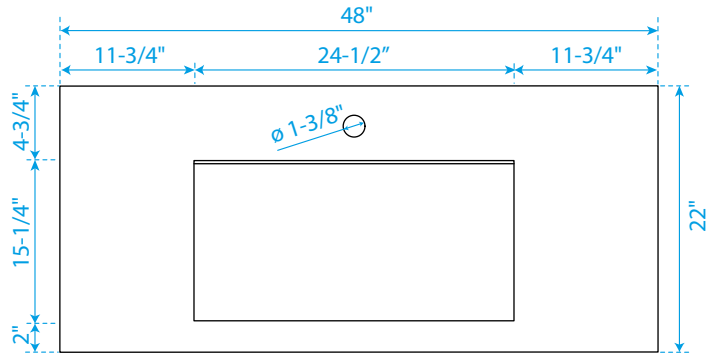

TOP VIEW OF VANITY CABINET

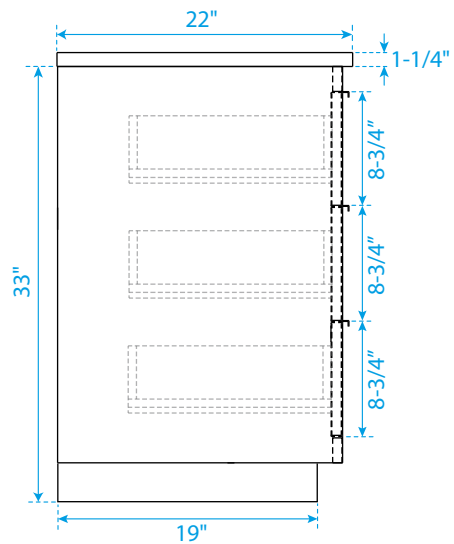
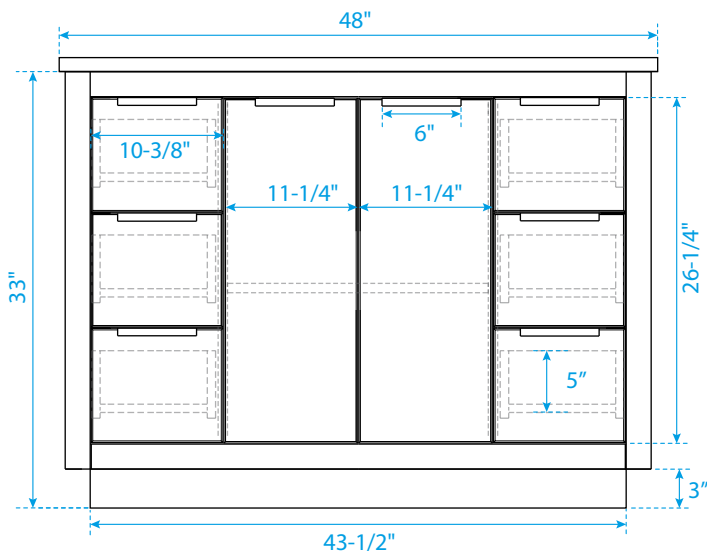
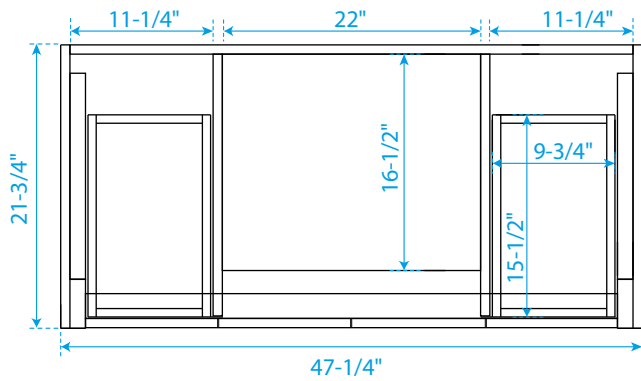
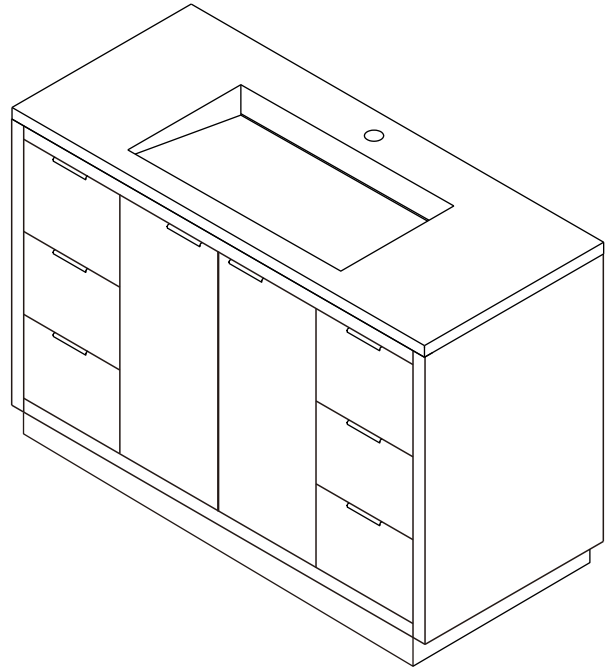

*Note: All measurements are $\pm 1/4"$.

WC-2828-48-SGL
with integrated sinks

WYNDHAM COLLECTION

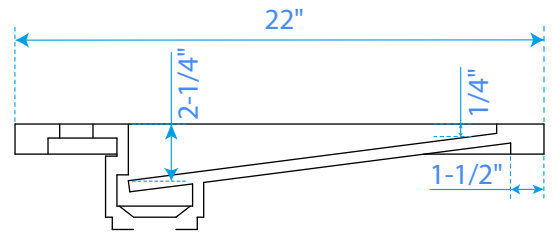
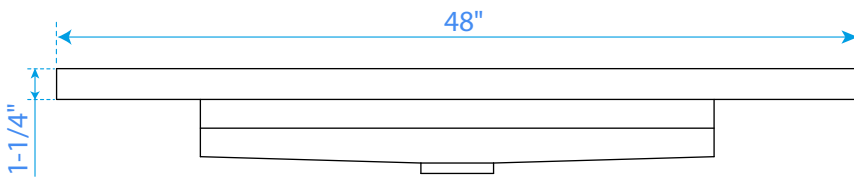
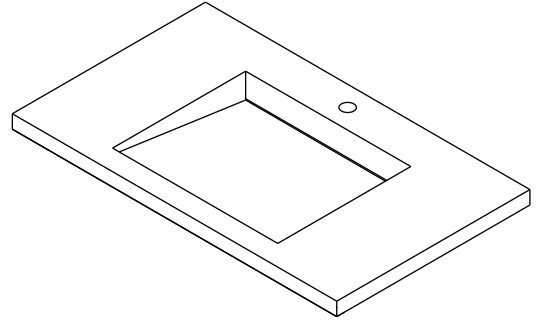
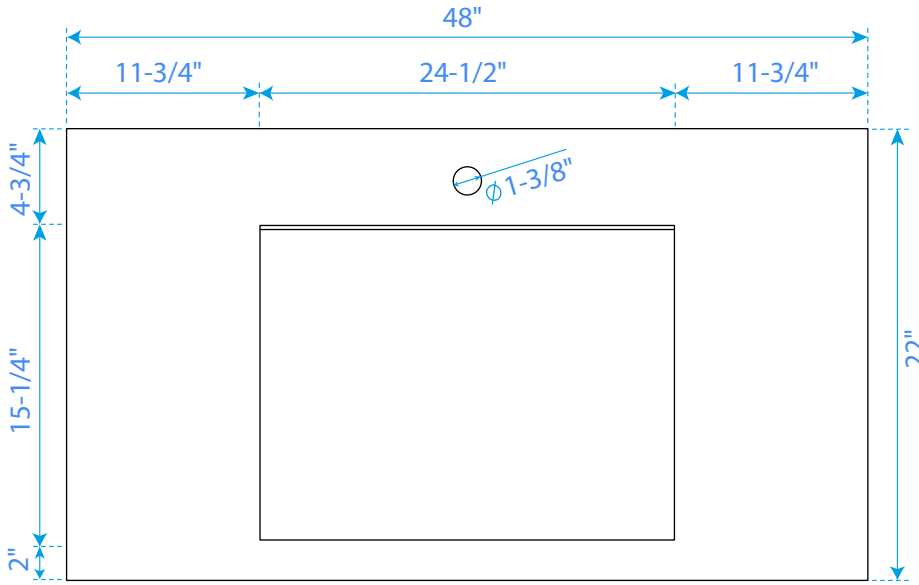

*Note: All measurements are $\pm 1/4"$.

WC-KC1-48-SGL-TOP