

WYNDHAM COLLECTION

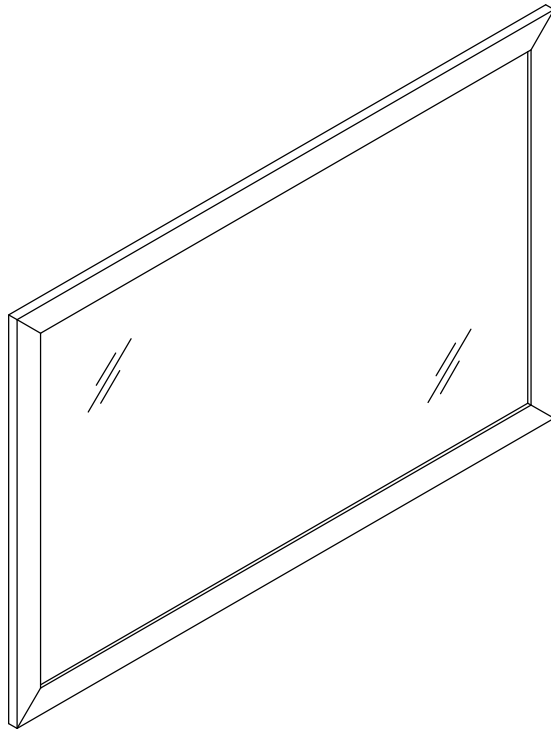
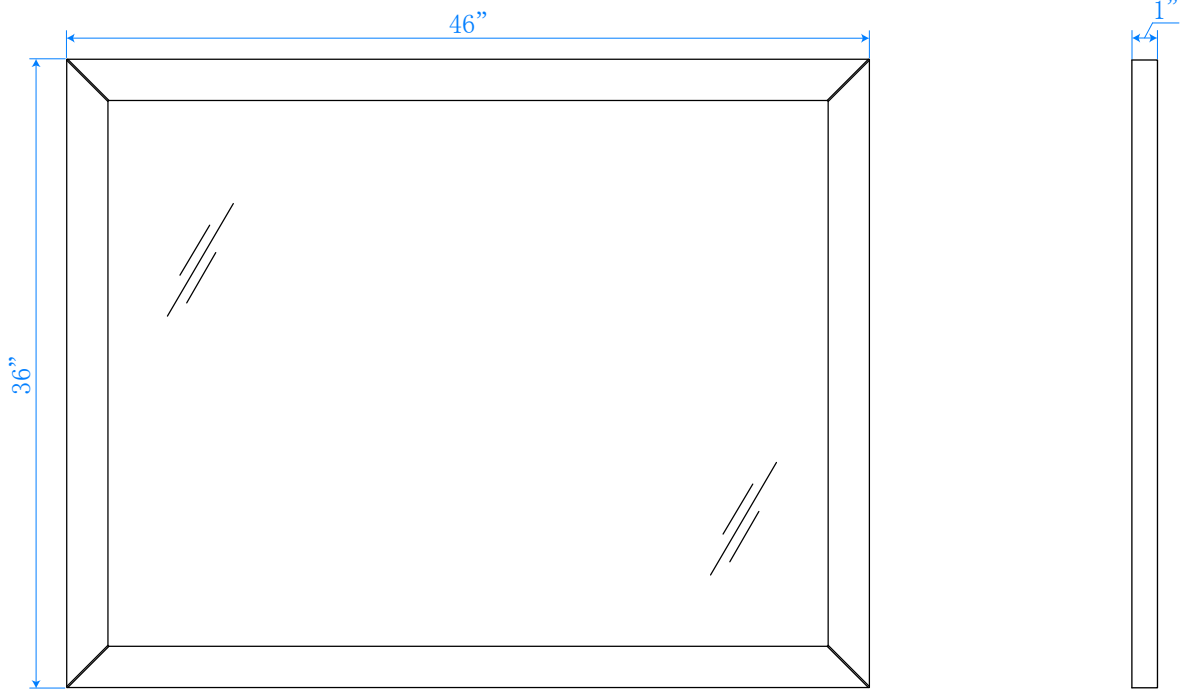

Note: All Measurements are $\pm 1/4"$

WC-2525-M46