

WYNDHAM COLLECTION

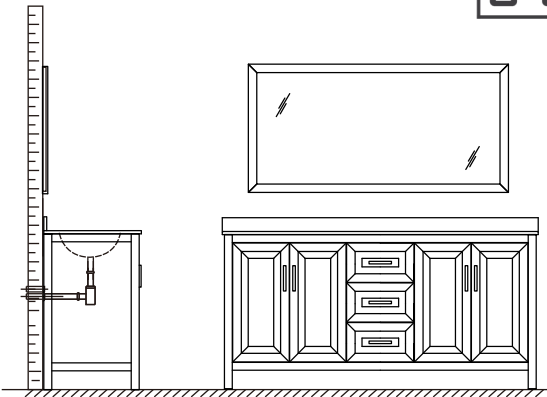

- Prior to installation please check received items against the "Packing List". Please report any missing items to your retailer immediately.
- Protect all surfaces from sharp objects, high heat sources, direct prolonged sunlight and chemical hazards.
- Professional installation recommended.
- Backsplash comes in two pieces.

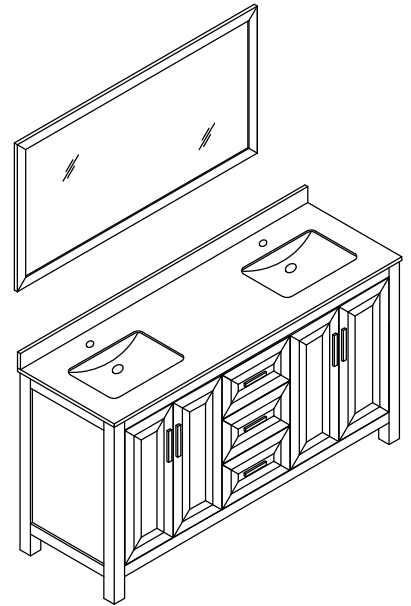

PACKING LIST

(Not all components may be included, depending upon your purchase)

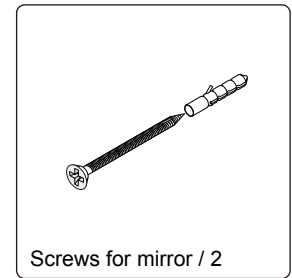
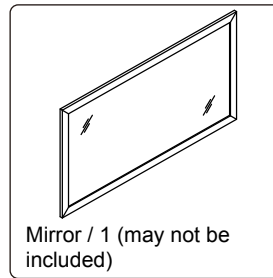
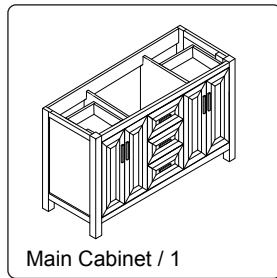
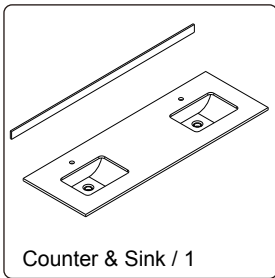

HOW TO ADJUST HINGES (if required)

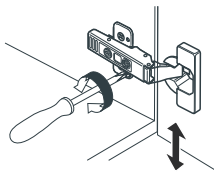

adjust height

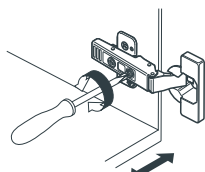

adjust laterally

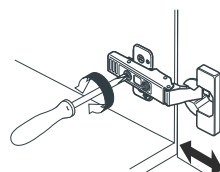

adjust depth

REQUIRED TOOLS NOT IN BOX

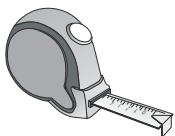

Tape measure



Pencil



Electric Drill

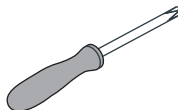

Phillips Screwdriver

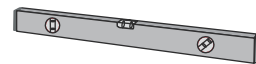

Spirit Level



Silicone sealant

WC-2525-80-DBL Installation Guide

WYNDHAM COLLECTION

INSTALLATION INSTRUCTIONS

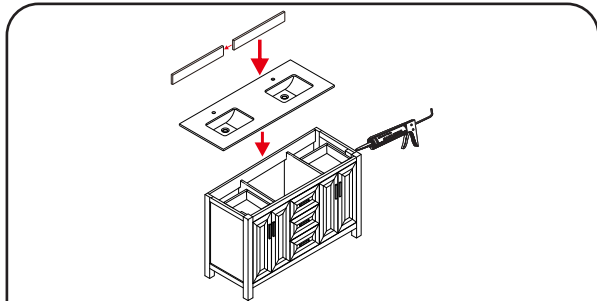

① Install the counter. Seal around the top of the cabinet with clear silicone sealant. Do not over apply. Allow to dry 24 hours for proper curing.

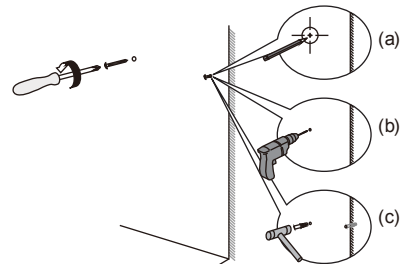

② Install the mirror: a) use a pencil to mark the placement of the screw holes on the wall, b) drill holes, c) insert the plastic wall anchors.

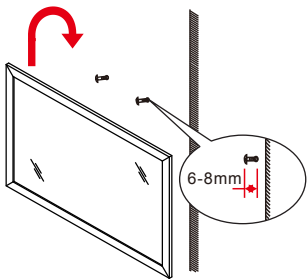

③ Install the screws into the wall anchors, leaving enough of the screw exposed to hang the mirror - approx 1/4" - 1/2".

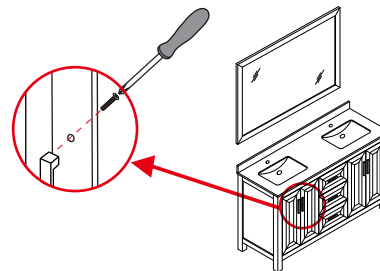

④ Remove the handles from inside the cabinet doors and drawers and reinstall on the outside. Do not over tighten when reattaching.

WC-2525-80-DBL
Installation Guide